

## SINGLE POINT LATCHES

Overall Dim: 4-1/4" x 5-1/2"  
Hole Size: 3-3/8" x 4-5/8"



**RUSTPROOF STEEL**  
**23-005** Locking  
**23-255** Non-Locking



**ZINC COATED STEEL**  
**23-075** Non-Locking with  
Heavy-Duty Slam Action Latch



**STAINLESS STEEL**  
**23-010** Locking  
**23-260** Non-Locking

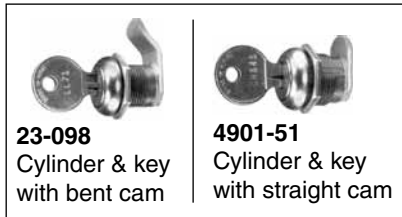

**23-098**  
Cylinder & key  
with bent cam

**4901-51**  
Cylinder & key  
with straight cam

## JUNIOR SIZE FLUSH LATCHES

Overall Dim: 3-5/8" x 4-11/16"  
Hole Size: 2-3/4" x 3-3/4"



**RUSTPROOF STEEL**  
**23-015** Locking  
**23-265** Non-Locking



**STAINLESS STEEL**  
**23-020** Locking  
**23-270** Non-Locking

**23-086** Cylinder and Key for  
all Junior Size Latches

## PADDLE LATCH

### Replaces Stahl Paddle Latch

Overall Dim: 5-1/4" x 6-1/2"  
Hole size: 4-1/4" x 5-1/2"



Front View



Back View



**4960Z** - Paddle style latch with cylinder and Key, zinc

## ROTARY LATCH

Overall Dim: 4-1/4" x 5-1/2"  
Hole Size: 3-1/4" x 4-1/2"

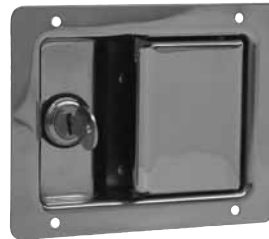

Front View

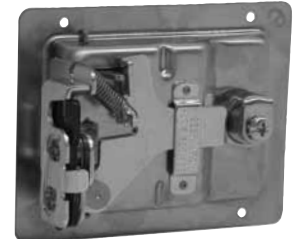

BackView

**23-150** - Rotary Latch, Polished Stainless Steel.  
Includes cylinder and key Number CH-501.

## SINGLE POINT "T" HANDLE LATCH

Overall Dim: 4-3/4" x 4-7/8"  
Hole size: 3-1/8" x 3-3/4" plus cylinder

**8400Z** - "T" Handle Latch  
Single point lock with  
adjustable latch for varied  
door thickness. Zinc plated.

**8400-61** Replacement  
Cylinder and key for  
8400Z

**15-621** Replacement  
cylinder & Key for old  
style 8004Z

**4874** Gasket only



UTILITY HDWR.

## 2-POINT DEAD BOLT "T" HANDLE

Overall Dim: 4-7/8" x 4-3/4"  
Hole Size: 3-3/4" x 3" plus cylinder.



99-561

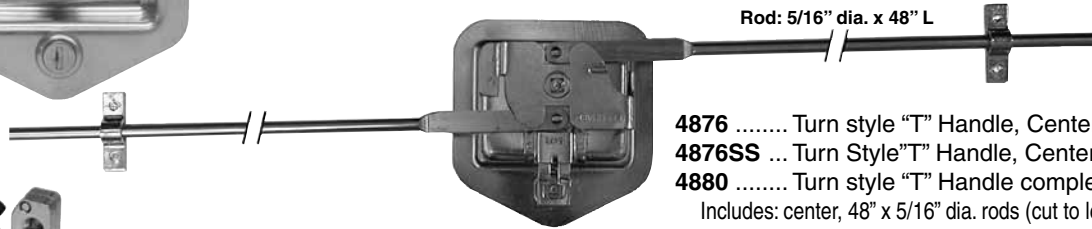

Rod: 5/16" dia. x 48" L

- 4876 ..... Turn style "T" Handle, Center only, Zinc
- 4876SS ... Turn Style "T" Handle, Center only, Stainless Steel
- 4880 ..... Turn style "T" Handle complete assembly, Zinc  
Includes: center, 48" x 5/16" dia. rods (cut to length), (2) rod guides.
- 4880-SS .. Same as 4880 except Stainless Steel.
- 4874 ..... Gasket only
- 99-561 ..... Slam Latch

## SINGLE ROTOR COMPARTMENT LATCH



10330-35

4-1/2" x 5-1/2" w/1/2" flange



70-100

**10330-35** - Rotary Compartment Latch with primary and secondary latching positions. Includes cylinder and key. Zinc plated. Use strike bolt 70-100.

**70-100** Striker Bolt Zinc plated and heat treated to comply with SAE grade 8 specification.

## ROD CONTROLLED PADDLE LATCH

Overall Dim: 5-3/4" x 4-3/4"  
Hole size: 3-3/8" x 4-1/2"



Front View



Back View

**23-175** - Rod controlled paddle latch, center only, Stainless Steel. This paddle latch accepts rods or cables for a variety of applications.

## "D" RING 2-POINT LOCK



**2102-L**  
Polished Stainless Steel  
"D" Ring Lock, 2-Point Lock  
2 Rods included

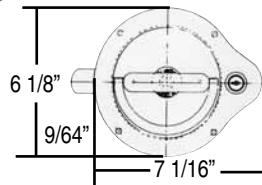

## ROTORY LATCH

- 1400L - Rotary Latch LH
- 1400R - Rotary Latch RH (shown)



3-5/8"

## SECURITY LOCK & HASP

Keeps swing doors secure!



**SL-100** - Zinc plated security lock, shielded



**SLH-100** - Zinc plated hasp for security lock

- Cylindrical lock provides maximum protection.
- Hasp shields the cylinder, providing extra security
- Heavy-duty zinc-plated steel lock. Zinc-plated & black powder coated hasp.
- Includes all mounting fasteners.
- Lock & hasp sold separately.

## COMPARTMENT DOOR HINGE

Dim: 2-1/4"L x 19/32"W  
with 3/8" hole



- 243LH** Left Hinge, Alum
- 243RH** Right Hinge, Alum

## LATCH CAM

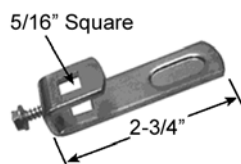

**NEW**  
**25-175** Latch Cam with set screw. Fits 5/16" square shaft. Overall length: 2-3/4".

**PINTLE HOOKS HEAVY-DUTY  
SWIVEL-TYPE PINTLE HOOKS**

**DROP FORGED RIGID PINTLE HOOKS**

**41-130**  
**15 Ton Pintle Hook**  
6,000 lbs. max. vertical load  
30,000 lb. max. gross trailer weight  
Weight: 11.0 lbs.



**41-140**  
**20 Ton Pintle Hook**  
8,000 lbs. max. vertical load  
40,000 lb. max. gross trailer weight  
Weight: 13.1 lbs.



**DRAWBARS**



**LW-10** Forged steel Drawbar  
2.5" I.D. O-Ring  
1000 lbs verticle load  
10,000 lbs. max gross trailer weight (MGTW)



**BDB12503** Forged Alloy Steel Drawbar with Nut; 2.5" I.D.; 5-1/2" O.D. with 1.5" section  
3000 lbs. verticle load; 15,000 lbs. MGTW

**BDB12492H** Forged Alloy Steel Drawbar with Nut; 3" I.D.; 6-1/4" O.D. with 1-5/8" section  
9000 lbs. verticle load; 45,000 lbs. MGTW



**BDB125015** Heavy-Duty Forged 4-Bolt Mount Drawbar; 2.5" I.D. O-Ring with 1.5" section  
7000 lbs. verticle load; 42,000 lbs. MGTW  
Weight 17.1 lbs.

**BDB1385** Forged 4-Bolt Mount Drawbar (.78" mtg. hole size); 3" I.D. O-Ring with 1.62" section  
15,000 lbs verticle load; 60,000 lbs. MGTW  
Weight 20 lbs.



**B18128** Trailer coupler adjustable eye assembly with 3 position channel & fastener. 3" dia. ductile cast iron eye and formed steel bracket, 1-9/16" section eye. M.V.L. 2000 lbs; M.G.T.W. 12,000 lbs.

*Forged Swivel-Type Pintle Hooks are spring cushioned. The swivel action provides torsional relief of the coupling. Drawbar eye dimensions: 2-3/8" to 3" I.D. with 1-1/4" to 1-5/8" diameter section. Includes, mounting information, spec. sheet, drilling template and capacity decals. For off road applications capacities are reduced by 25%.*

**41-220 - 15 Ton Swivel-Type Pintle Hooks**  
6,000 lbs. max. vertical load  
30,000 lb. max. gross trailer weight  
Weight: 34 lbs.



**41-295**  
Replacement Safety Pin with Chain

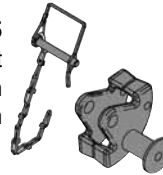

**41-294 - Replacement Safety Latch**

**41-240 - 15 Ton Swivel-Type Pintle Hooks**  
6,000 lbs. max. vertical load  
30,000 lb. max. gross trailer weight  
Weight: 42 lbs.



**41-295**  
Replacement Safety Pin with Chain

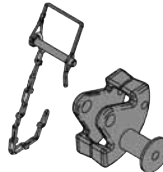

**41-294 - Replacement Safety Latch**

**41-245 - 25 Ton Swivel-Type Pintle Hooks**  
6,000 lbs. max. vertical load  
50,000 lb. max. gross trailer weight  
Weight: 40 lbs.



**41-250 - 25 Ton Swivel-Type Pintle Hooks**  
6,000 lbs. max. vertical load  
50,000 lb. max. gross trailer weight  
Weight: 47 lbs.



**41-255 - 30 Ton Swivel-Type Pintle Hooks**  
12,000 lbs. max. vertical load  
60,000 lb. max. gross trailer weight  
Weight: 36 lbs.



**UTILITY HDWR.**

## PINTLE HOOKS LIGHT-DUTY

### DROP FORGED RIGID PINTLE HOOKS

All Pintle Hooks are finished with black powder coat and include mounting information, spec. sheet, drilling template and capacity decals.



**41-135**  
**5 Ton Pintle Hook**  
2,000 lbs. max. vertical load  
10,000 lb. max. gross trailer weight  
Weight: 7.5 lbs.



**41-133**  
**8 Ton Pintle Hook**  
3,200 lbs. max. vertical load  
16,000 lb. max. gross trailer weight  
Weight: 9.0 lbs.

### 6-TON RECEIVER-MOUNT COMBINATION PINTLE AND BALL MOUNT HITCHES

**Receiver Mount  
Combination Pintle  
Hook/Ball** hitches are in black powder coated finish. Has a 16" overall length with 2" square shaft. Drawbar eye dim: 2-1/2" to 3" with 1-1/4" to 1-9/16" dia. section. Weight: 20 lbs. Capacity: 2400 lbs. max. vertical load, 12,000 lbs. max. gross trailer weight.



**41-191** ..... with 1-7/8" Ball Size  
**41-192** ..... with 2" Ball Size  
**41-193** ..... with 2-5/16" Ball Size

**Replacement Balls**  
**41-124** ..... 1-7/8"  
**41-125** ..... 2"  
**41-126** ..... 2-5/16"

### SNAPPER PINS

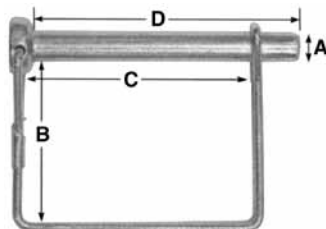

Part No.	A	B	C	D
<b>66-045</b>	3/16"	1-5/8"	1-9/16"	1-3/4"
<b>66-050</b>	1/4"	1-3/4"	1-1/2"	2"
<b>66-053</b>	5/16"	2-7/16"	1-3/4"	2-3/4"

### DROP FORGED COMBINATION PINTLE AND BALL MOUNT HITCHES

All Drop Forged Combination Pintle Hooks are black powder coat finished. The forged steel hitch ball is interchangeable. Draw bar eye dimensions: 2-1/2" to 3" I.D. with 1-1/4" to 1-9/16" diameter section. Includes drilling template and capacity decals.

**8 Ton Combination Hitches**  
3,000 lbs. max. vertical load  
16,000 lb. max. gross trailer weight  
Weight: 13 lbs.

**41-121** ..... with 1-7/8" Ball Size  
**41-122** ..... with 2" Ball Size  
**41-123** ..... with 2-5/16" Ball Size



#### Replacement Balls

**41-124** ..... 1-7/8"  
**41-125** ..... 2"  
**41-126** ..... 2-5/16"

**10 Ton Combination Hitches**  
4,000 lbs. max. vertical load  
20,000 lb. max. gross trailer weight  
Weight: 20 lbs.

**41-127** ..... with 2" Ball Size  
**41-128** ..... with 2-5/16" Ball Size



#### Replacement Balls

**41-118** ..... 2"  
**41-119** ..... 2-5/16"

### MULTI-HEIGHT PINTLE HOOK MOUNTS

#### FEATURES

- Continuous Welds
- Black powder coat finish
- High and Low Positioning
- Welded Support Bracket
- Solid shank (\*tubular shank on 41-158)

Designed to fit hitches on this page and other similar pintle hooks.

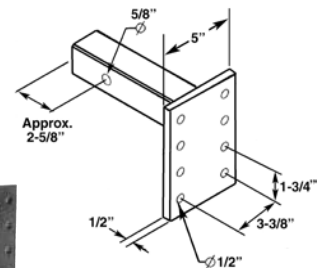

41-148



41-150



41-155



41-158

Part No.	Shank Dim:	Plate Dim:	M.V.L.	M.G.T.W.	Pairs of Holes
<b>41-148</b>	2" x 9"	5" x 3.75"	4,000 lbs.	20,000 lbs.	2
<b>41-150</b>	2" x 9"	5" x 7.38"	2,000 lbs.	10,000 lbs.	4
<b>41-152</b>	2" x 10.5"	5" x 5.75"	2,800 lbs.	14,000 lbs.	3
<b>41-153</b>	2" x 10.5"	5" x 7.38"	2,000 lbs.	10,000 lbs.	4
<b>41-155</b>	2" x 12.25"	5" x 12.5"	2,000 lbs.	10,000 lbs.	7
<b>41-157</b>	2" x 14.25"	5" x 12.5"	2,000 lbs.	10,000 lbs.	7
<b>*41-158</b>	2.5" x 12"	5" x 6.13"	3,200 lbs.	16,000 lbs.	3

\*Tubular shank

UTILITY HDWR.

**SWIVEL HITCH PIN with SPRING CLIP**



**NEW**

**NEW**  
**HP625SC** - Swivel Hitch Pin with Spring Clip. 5/8" Zinc pin with integral spring clip. Spring clip rotates to lock in place. 5-3/8" overall length.

**3 TON BALL MOUNTS**

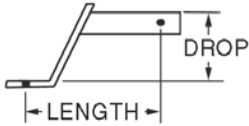

UB-210-B



UB-409-B



UB-612-B

- 600 lbs. max. vertical load
- 6000 lbs max. gross trailer weight
- Able to raise or lower ball height
- Black powder coat finish
- Fits all 2 x 2 Receivers

**UB-210-B**  
2" drop, 3/4" rise, 10" length  
**UB-409-B**  
4" drop, 2" rise, 9" length  
**UB-612-B**  
6" drop, 5" rise, 12" length

**RECEIVER TUBES**



**RT25812** - 2"ID x 12"L Receiver Tube  
• Weight 7.0 lbs

**RT25818** - 2"ID x 18"L Receiver Tube  
• Weight 10.0 lbs

- Cast steel collar
- Plain finish
- Solid stress collar opening
- 5/8" Hitch pin hole

**BOLT-ON RECEIVER TUBE**



**1804055** - 2" Bolt-on receiver tube  
2" I.D. x 6L"  
• Tube welded to 1/2" thick steel mounting plate  
• Standard 4 hole pintle hook pattern  
• Cast steel collar  
• Black powder coat finish  
• Solid stress collar opening  
• 5/8" Hitch pin hole  
• M.G.T.W. 20,000 lbs  
• M.V.L. 2,000 lbs  
• Weight 7.9 lbs

**TRI-BALL HITCH**

**1802200** - Triball Hitch, Black  
Rotate the ball for three sizes  
1-7/8", 2" & 2-5/16".  
Solid Shank: 2" square  
Overall Length: 12"  
Hole size: 5/8"  
Hole from end: 2-1/2" & 4"  
Weight: 20 lbs.



**TRI-BALL HITCH with HOOK**

**NEW**  
**1802208** - Triball Hitch, Black  
Rotate the ball for three sizes  
1-7/8", 2" & 2-5/16" or Tow Hook  
Tubular Shank: 2" square  
Overall Length: 12"  
Hole size: 5/8"  
Hole from end: 2-1/2"  
Weight: 13.4 lbs.



**NEW**

**TILT-A-HITCH®**



**NEW**

**NEW**  
**1802300** - Tilt-A-Hitch®  
Converts any trailer into a tilting trailer. Provides a simple tilt adjustment at the hitch to increase ground clearance between load ramps and trailer floor. Overall Dim: 25"L x 10-3/4"H  
Mounts in 2" receiver. 1/4" Steel plate construction. Black powder coat finish. 1" Tow Ball shank opening (ball not included). 12" Lift range at the hitch with multiple positions. Two height adjustment pins included. 8000 lbs. maximum tongue weight. Class 4; V5 rated. Weight: 31 lbs.

**INSPECTION DOORS**

Designed to be welded into dump body tailgates. Turn buckle door travel adjustment. Bolt-on cast iron door handle interchanges for left or right hand operation. Over-center positive locking handle. Detented door holder ( or positioner). Durable steel construction. Zinc chromate primer finish.



**NEW**  
**CCD0714** - Inspection Door w/Detent, 7-1/4"H x 13-3/4"W  
for 1-Ton to Super Duty Dumps. (shown open)  
**NEW**  
**CCD1314** - Inspection Door w/Detent, 12-3/8"H x 13-1/2"W  
for Medium & Heavy Class Dumps.

**NEW**

## Proportional Brake Controller for Single and Tandem Axle Tow Vehicles



**BC2AP** - Proportional Brake Controller for single and tandem axle tow vehicles that automatically monitors and measures tow vehicle deceleration. Roller style gain control for easy tuning to meet the systems braking requirements. Manual braking slide control lever overrides gain setting for full power emergency braking and activates trailer braking lights for added safety. LED indicator light intensifies as braking power increases and warns of short circuits. 5 year warranty.

### BRAKE CONTROLLER WIRING HARNESS

OEM style wiring harness with simple quick connect 3 foot leads.

**BCHF** - Wire harness that fits Ford

**BCHD** - Wire harness that fits Dodge

**BCHGM9901** - Wire harness that fits 1999-2002 GM

**BCHGM03** - Wire harness that fits 2003-on GM

### LIGHT DUTY TOW HOOKS

Drop Forged  
Chrome Plated or  
Black Enameled  
Max. Safe Working  
Load: 10,000 lbs



**41-027**  
Chrome Plated



**41-028**  
Black Enameled

### EMERGENCY TOW STRAPS

**41-015** - 15 foot Tow Strap  
**41-020** - 30 foot Tow Strap



2" Webbing rated at 10,000 lbs.; absorbs towing jerks. Flat snap hook are zinc coated and rated at 11,000 lbs.

### LASHING RING WITH MOUNTING BRACKET



**41-038** - Ultimate breaking strength rated at 11,700 lbs. 1/2" dia. ring with 2-3/8" inside dimension. Bracket: 1-5/8"W x 3/16" thick. Mtg hole centers: 2".



**41-040** - Ultimate breaking strength rated at 18,390 lbs. 5/8" dia. ring with 3" inside dimension. Bracket: 1-7/8" W x 3/8" thick.



**41-046** - Ultimate breaking strength rated at 26,500 lbs. 3/4" dia. ring with 3" inside dimension. Bracket: 1-7/8" wide x 3/8" thick.

## HIGH VISIBILITY TRUCK AND TRAILER FLUORESCENT ORANGE MARKERS

This extra heavy duty marker was designed for highway and municipal plow requirements. The 3/4" O.D. tube is constructed of low temperature nylon with a full 1/8" wall size. The 28" long marker offers 240% more surface area than conventional markers. These markers are sold in sets of two with fasteners for vertical mounting. Horizontal and angle adaptor kits are available as a separate kit.



Available in 28", 36" and 48" Lengths



153-0002  
45° Angle  
Adaptor Kit



153-0004  
Horizontal  
Adaptor Kit

PART NO.	DESCRIPTION
<b>153-0024</b>	24" Marker Kit
<b>153-0028</b>	28" Marker Kit
<b>153-0031</b>	36" Marker Kit
<b>153-0048</b>	48" Marker Kit
<b>153-0002</b>	45° Angle Adaptor Kit
<b>153-0004</b>	Horizontal Adaptor Kit

### RACK CONNECTIONS



Right Hand Pair



Left Hand Pair

7" overall length with 11/32" holes formed from 2-1/2" x 3/16" stock.

**41-060** - Straight Side Rack Connections. One set is illustrated consisting of 4 pieces. One L.H. pair and one R.H. pair. Available zinc plated.



Right Hand Pair

Left Hand Pair

3-5/8" overall length to inside of angle with 11/32" holes formed from 2-1/2" x 3/16" stock

**41-065** - Corner Gate Connection. One set is illustrated consisting of 4 pieces. One L.H. pair and one R.H. pair. Available zinc plated.

### SECURITY LATCH



**41-080** 4 Piece Straight Latch with latch catch, Plain  
**41-081** Latch Catch only



**41-085** 4 Piece Corner Latch with latch catch, Plain  
**41-086** Corner Catch only

## LINCH PINS

Part No.	Description
155-0235	Linch pin, 1/2"
315-0120	Linch pin, 7/16"



## POLY-COATED HITCH PIN W/COTTER

Part No.	Description
66-301	1/2" x 4"
66-307	5/8" x 4"
66-311	3/4" x 4-1/2"



## HITCH PIN W/COTTER

Part No.	Description
66-300	1/2" x 4-1/2"
66-305	5/8" x 6-1/4"
66-310	3/4" x 4-1/4"
66-315	3/4" x 6-1/4"

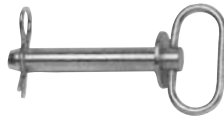

## TRAFFIC CONES & HOLDERS

**NEW**



High Visibility Traffic Cone. Molded of long lasting P.V.C. Fade resistant bright orange.



Holds ten 18" or five 28" cones. Mount holes are pre-punched. Silver powder coat finish. 22" tall. Mounts on truck or trailer

**TCH10H** – Horizontal Mount Traffic Cone Holder  
**TCH-10V** – Vertical Mount Traffic Cone Holder.

**NEW**

99-018 - 18" Cone  
99-028 - 28" Cone

## HIGH VISIBILTY WARNING FLAG



**NEW** 99-075 - Bright Orange High Visibility Warning Flag. Vinyl coated nylon for extra durability. 3/4" hardwood shaft will not conduct electricity.

## ROPE RINGS



**PO-601** – Recessed Rope Ring with safe working load of 285 lbs. Zinc plated, requires 3" diameter mounting hole in 3/8" or thicker material (not for lifting).



**B-32F** – Surface Mount Rope Ring with safe working load of 500 lbs. Zinc plated, 3/8" forged rope ring, designed for carriage bolts (not for lifting).



**B-20** – Surface Mount Rope Ring with safe working load of 800 lbs. Zinc plated, 1/4" dia. Steel ring and formed steel clamp (not for lifting).

## TRAILER COUPLERS

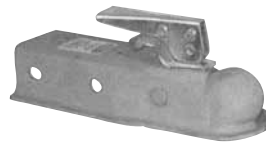

Part No.	Description	M.G.T.W.	Weight
91-058	Coupler, 2" ball, 2" channel	3,500 lbs.	4 lbs.
91-060	Coupler, 2" ball, 2-1/2" channel	3,500 lbs.	4.38 lbs
91-065	Coupler, 2" ball, 3" channel	3,500 lbs.	4.5 lbs.
91-091	A-Frame coupler, 2" ball	5,000 lbs.	6.7 lbs.
91-097	A-Frame coupler, 2-5/16" ball	10,000 lbs.	8.38 lbs.

## TRAILER JACKS



91-205/91-215



91-220



91-225



91-310



91-340



91-610

Part No.	Description
91-205	Tube jack swivel mount with 10" travel, 2000 lbs. capacity, top wind.
91-215	Tube jack swivel mount with 15" travel, 2000 lbs. capacity, top wind.
91-220	Tube jack swivel mount with 10" travel, 2000 lbs. capacity, side wind.
91-225	Bracket jack swivel mount with 15" travel, 2000 lbs. capacity, top wind.
91-310	2-1/2" Square tube jack with 26" travel, 7000 lbs. capacity, top wind.
91-340	2-1/2" Square tube jack with 26" travel, 7000 lbs. capacity, side wind.
91-610	Swing away jack with caster, 10" travel, 1000 lbs. capacity, side wind.

## PICKUP CAB PROTECTION

**Backracks** are made to protect the cab and rear window from damage and secure cargo to prevent shifting. Built rugged to perform the toughest jobs; Powder coated for maximum rust resistance. Installs within minutes, and the accessory brackets provide an easy, convenient method of mounting warning lights. Bedliner and toolbox friendly. Mill Supply carries a variety of strobe lamps, see page 224.

**Protect your Cab and Rear Window from Shifting Loads**



**Bar Style Backrack**



**Screen Style Backrack**

Call if you do not see your vehicle listed. There are many other vehicle applications available.



Classic



New Body

Bar Style	Screen Style	Applications
<b>39-116</b>		Silverado/Sierra Full Size - 2008-09, New Body Style
<b>39-109</b>	<b>39-163</b>	Silverado/Sierra Full Size - 1999-07, Classic Body Style
<b>39-108</b>	<b>39-168</b>	Ford F-150 - 2004-09
<b>39-102</b>	<b>39-167</b>	Ford F 150/250 - 1997-03 - Light duty Only
<b>39-101</b>	<b>39-166</b>	Ford F-Superduty - 1999-09
<b>39-114</b>	<b>39-174</b>	Dodge 1500 - 2002-09 & 2500/3500 - 2003-09

## STEEL UNDERBODY TOOLBOXES



- 14 gauge steel box, 12 gauge steel door
- Powder coated black
- 1/2" Thick gasket system
- Recessed and beveled door edges enhance watertight design
- Stainless steel hinge and paddle handle
- Reinforced door backbone protects latch mechanism

**84-2300** - Steel Underbody Toolbox, Black powder coated. 18" x 18" x 24". Has one Folding 'T' Handle

**84-2315** - Steel Underbody Toolbox, Black powder coated. 18" x 18" x 60". Has two Folding 'T' Handles

Visit us on the web at [www.millsupply.com](http://www.millsupply.com) to see other sizes and style toolboxes we carry.

## VERNIER ADJUSTABLE LOCKING CONTROL CABLES

### Vernier Heavy Duty Adjustable Locking Control Cable

.088 Dia. Stainless Steel Core - .375 Dia. Conduit

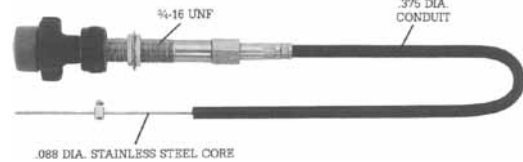

Part No.	Length	Part No.	Length
<b>17-106</b>	6ft	<b>17-120</b>	20ft
<b>17-110</b>	10ft	<b>17-125</b>	25ft
<b>17-115</b>	15ft	<b>17-130</b>	30ft

### Vernier Adjustable Locking Control Cable

.075 Dia. Stainless Steel Core - .260 Dia. Conduit

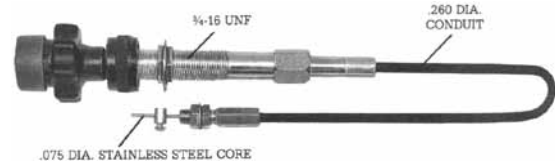

Part No.	Length	Part No.	Length
<b>17-215</b>	15ft	<b>17-225</b>	25ft
<b>17-220</b>	20ft	<b>17-230</b>	30ft
		<b>17-235</b>	35ft

### Spiral Wound P.T.O. and Pump Control Cable

3-1/2" Travel, Heavy Duty "T" Handle Locking Cable



Part No.	Length	Part No.	Length
<b>17-306</b>	6ft	<b>17-315</b>	15ft
<b>17-310</b>	10ft	<b>17-320</b>	20ft

### Choke Cable



Part No.	Length
<b>17-406</b>	6ft
<b>17-408</b>	8ft
<b>17-410</b>	10ft
<b>17-415</b>	15ft

UTILITY HDWR.

# CALIPERS FOR MEDIUM DUTY TRUCKS

All replacement calipers are new, no core return.

## Replaces Bendix

Fits GMC

Fits Chevrolet, GMC & Dodge

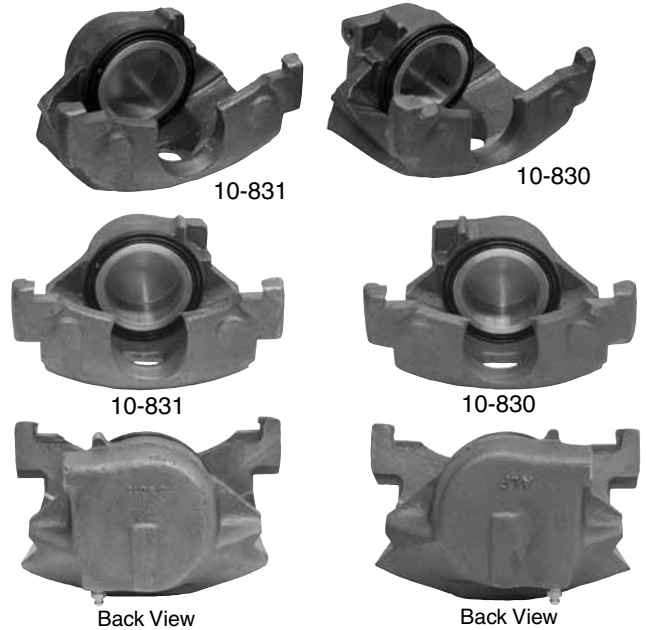
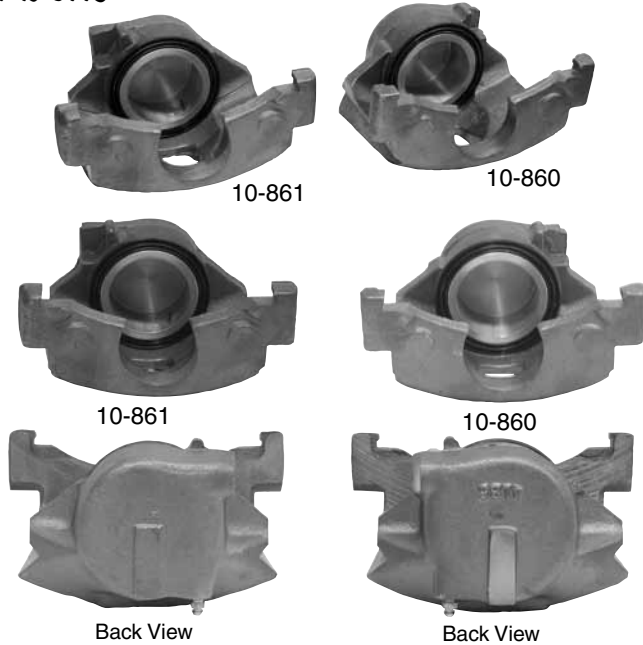

**10-861 RH Caliper**  
(Casting# 2238451L)  
Fits GMC w/3.38" single piston caliper steel piston, **US standard thread inlet**. Uses pads D184 & D149.

**10-860 LH Caliper**  
(Casting# 2238452R)  
Fits GMC w/3.38" single piston caliper steel piston, **US standard thread inlet**. Uses pads D184 & D149.

**10-831 RH Caliper**  
(Casting# 2238451L)  
Fits Chevrolet, GMC & Dodge w/3.38" single piston caliper steel piston, **Metric threaded inlet**. Uses pads D184 & D149.

**10-830 LH Caliper** (Casting# 2238452L) Fits Chevrolet, GMC & Dodge w/3.38" single piston caliper steel piston, **Metric threaded inlet**. Uses pads D184 & D149.

**Note:** The position of the caliper on the wheel (ahead or behind axle). If mounted ahead of the axle, the RH caliper mounts on the left side of the vehicle and LH caliper on the right side of the vehicle.

**Note:** The position of the caliper on the wheel (ahead or behind axle). If mounted ahead of the axle, the RH caliper mounts on the left side of the vehicle and LH caliper on the right side of the vehicle.

UTILITY HDWR.

Fits Freightliner

Fits Chevrolet, GMC & Navistar

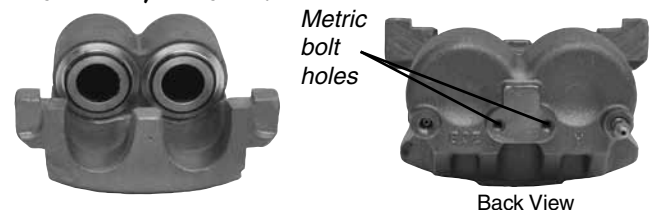
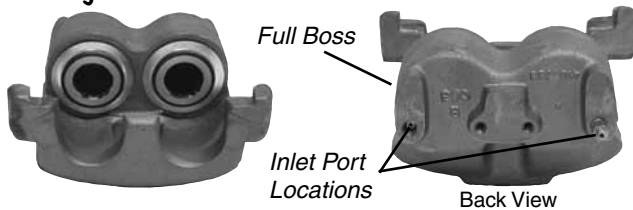

**10-827 Caliper** (Casting# 4151733) Fits Freightliner w/air ride suspension w/2.60" dual piston caliper, **note inlet port location w/full boss**. Uses pads D184.

**10-828 Caliper** (Casting# 4150844) Fits Chevrolet, GMC & Navistar w/2.88" dual piston caliper. Metric brake line mounting holes, metric bolts not included. Uses pads D225.

## Replaces Bosch

Fits IHC, Navistar, Ford, Sterling & Thomas Built

Fits IHC, Navistar, Ford, Sterling & Thomas Built



**10-833 Caliper** (Casting# 4153269) Fits IHC, Navistar, Ford, Sterling & Thomas Built, fits right or left side, 66mm, **w/pin mount**. Uses pads D-786 (20.3mm).

**10-834 Caliper** (Casting# 4153222) Fits IHC, Navistar, Ford, Sterling & Thomas Built, fits right or left side, 73mm, **w/pin mount**. Uses pads D-786A (26.8mm).

# CALIPERS FOR MEDIUM DUTY TRUCKS

Replaces Dayton

All replacement calipers are new, no core return.

Fits Ford

Fits Ford

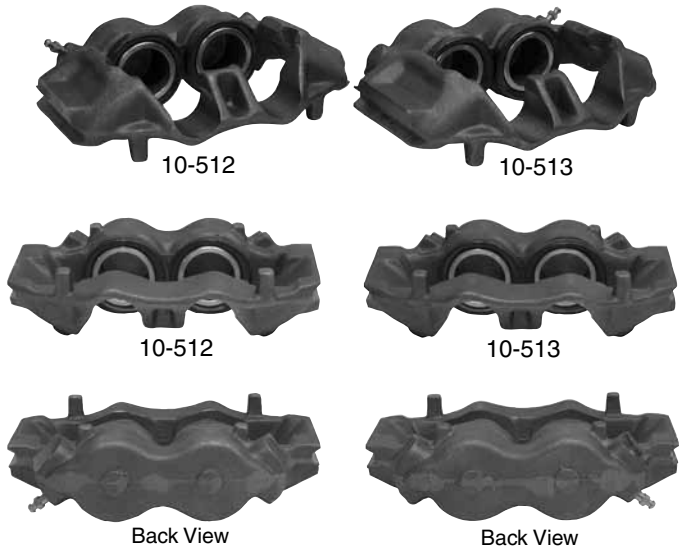
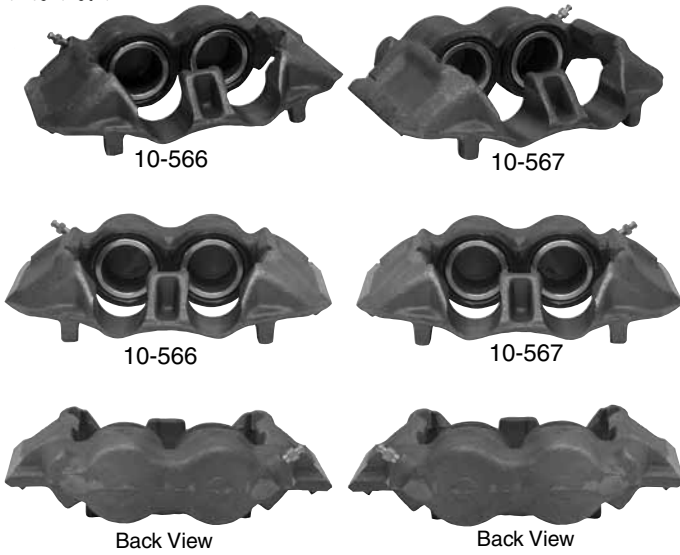

**10-566 LH Caliper**  
(Casting# 390) Fits Ford,  
2.188" dual piston caliper  
w/slide rail design. **3/8x24  
inlet w/aluminum pistons.**  
Uses pad # D120.

**10-567 RH Caliper**  
(Casting# 390) Fits Ford,  
2.188" dual piston caliper  
w/slide rail design. **3/8x24  
inlet w/aluminum pistons.**  
Uses pad # D120.

**10-512 LH Caliper**  
(Casting# 471 & 573) Fits Ford,  
2.188" dual piston caliper  
w/V-way design. **3/8x24  
inlet w/aluminum pistons.**  
Uses pad # D450.

**10-513 RH Caliper**  
(Casting# 471 & 573) Fits Ford,  
2.188" dual piston caliper  
w/V-way design. **3/8x24  
inlet w/aluminum pistons.**  
Uses pad # D450.

## Replaces Kelsey Hayes

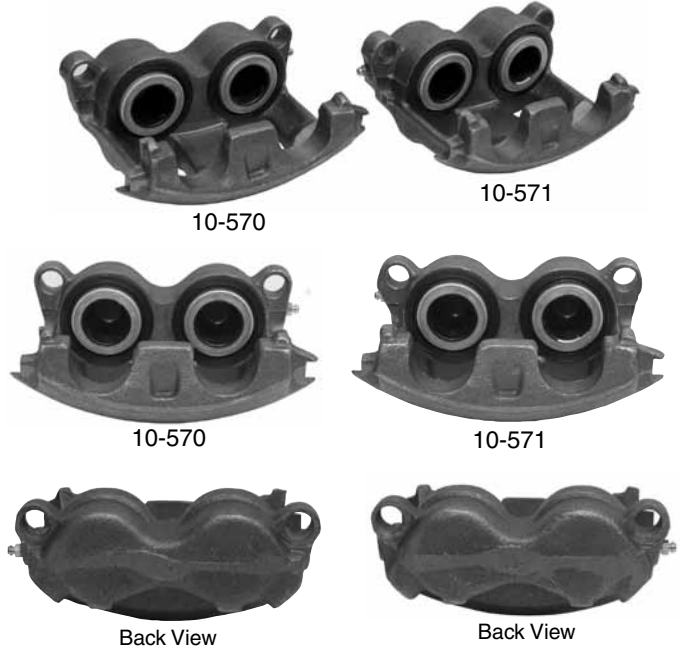
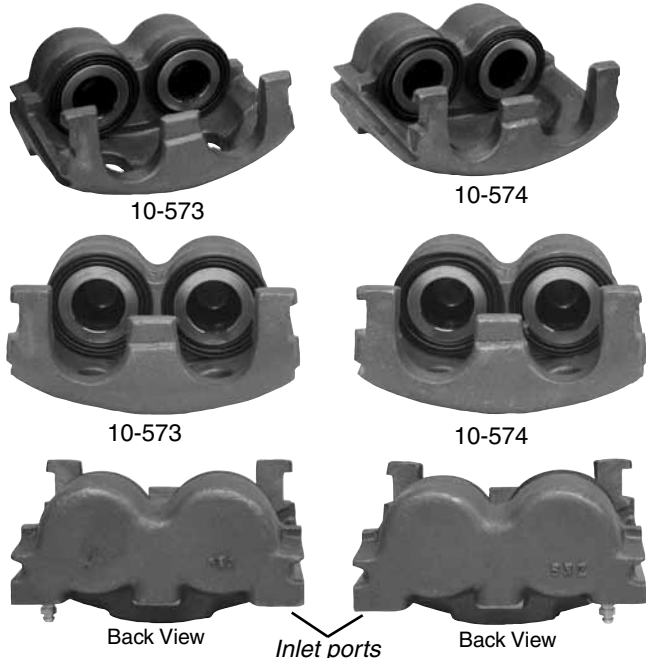

**10-573 LH Caliper**  
(Casting# KH12068401) Fits  
Ford E & F450, 2.362"  
(60mm) dual piston caliper,  
**3/8x24 inlet ports.** Uses  
pad # D411.

**10-574 RH Caliper**  
(Casting# KH12068401) Fits  
Ford E & F450, 2.362"  
(60mm) dual piston caliper,  
**3/8x24 inlet ports.** Uses  
pad # D411.

**10-570 LH Caliper**  
(Casting# KH12795101) Fits  
Ford E & F350, 56mm dual  
Phenolic piston caliper,  
**3/8x24 inlet port.** Uses  
pad # D655.

**10-571 RH Caliper**  
(Casting# KH12795101) Fits  
Ford E & F350, 56mm dual  
Phenolic piston caliper,  
**3/8x24 inlet port.** Uses  
pad # D655.

# DISC BRAKE PADS FOR MEDIUM DUTY TRUCKS

**Carbon-based Metallic Friction Material. Specifically formulated for severe duty cycles and designed to protect your rotors.**



**D149** - Disc brake pads set Inner/Primary 7.200 L Outer/Secondary 8.120 L Fits Chevrolet, Dodge, GMC



**D184** - Disc brake pads set Inner/Primary 8.070 L Outer/Secondary 10.060 L Fits Chevrolet, Dodge, Freightliner, GMC, International, Sterling Acterra

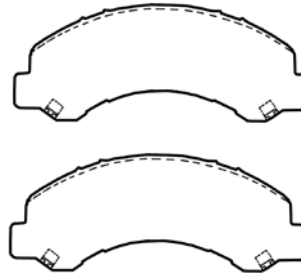

**D826** - Disc brake pads set 8.120 L. Fits Chevrolet, GMC, Isuzu



**D827** - Disc brake pads set 8.280 L. Fits Chevrolet, GMC, Isuzu



**D224** - Disc brake pads set 8.400 L. Fits Chevrolet, Ford, Isuzu, Kodiak

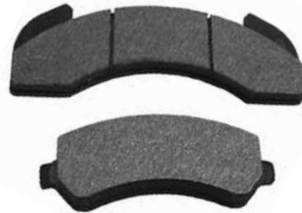

**D225** - Disc brake pads set Inner/Primary 8.070 L Outer/Secondary 10.620 L Fits Chevrolet, Freightliner, International, Sterling Acterra



**D546** - Disc brake pads set Inner/Primary 7.210 L Outer/Secondary 9.380 L Fits Chevrolet, GMC, Isuzu

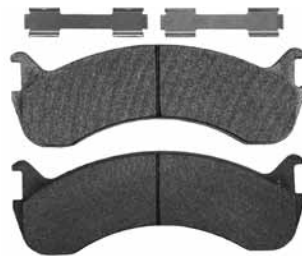

**D786** - Disc brake pads set 9.610 L x .799 W. Fits Ford, Freightliner, International, Sterling Acterra

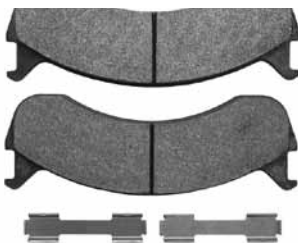

**D786A** - Disc brake pads set 9.610 L x 1.055 W. Fits Ford, Freightliner, International, Sterling Acterra



**D825** - Disc brake pads set 8.120 L. Fits Chevrolet, GMC, Isuzu

## COILED NYLON AIR BRAKE TUBING ASSEMBLY KITS

- Assemblies include permanently swagged end fittings with heavy gauge spring for extra support
- Each kit contains one Emergency (RED) and one Service (BLUE) nylon tubing assembly
- Assemblies meet SAE J844 and FMVSS 106 requirements

**12 Foot Working Length**      **15 Foot Working Length with Long Lead**



- 6 Inch Leads
- 1/2" Male Pipe Thread Ends

**022002** - Standard Kit Shown  
**022004** - Emergency (Red) Only  
**022009** - Service (Blue) Only

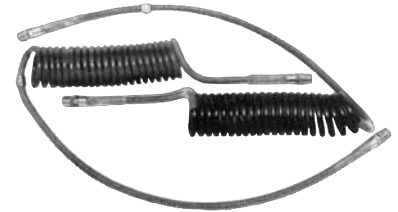

- One 40" Lead
- One 12" Lead
- 1/2" Male Pipe Thread Ends

**022001** - Standard Kit (shown)  
**022005** - Emergency Kit (Red)  
**022008** - Service (Blue) Only

## HOSE & CABLE SUSPENDERS

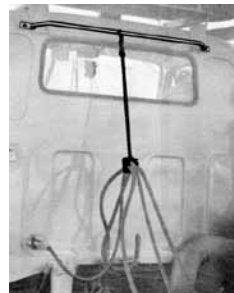

**580066** - Slide Bar Hose Suspenders Kit - permits the traverse movement of air and electrical lines. Slide bar is 3/4" O.D. heavy gauge stainless steel tubing with 42-1/2" mounting centers. **Kit includes:** Slide bar, 24" hose and cable suspender, nylon ring and zinc plated steel "S" hook



**580081** 5" (non-stretch)  
**580082** 12" Overall Length  
**580086** 16" Overall Length  
**580094** 24" Overall Length



# INDEX

Accelerator Cables .....	19,45,68	Fuel Tanks & Caps, Oshkosh & J-D.....	68	Roof Vents .....	166
Adhesives/Sealants .....	92	Fuel Tank Doors .....	90	Rub Rail Caps .....	91
Air Brake Tubing & Suspenders .....	238	Fuse Kits .....	207	Rubber Bumpers.....	5
Air Helper Springs.....	75	Gaskets, Engine Cover .....	84	Rubber Fender .....	93
Aluminum Replacement Panels .....	91	Gauges, Dash.....	19	Safes, Deposit.....	171
Audio Systems.....	209	Glo-Plug Controller .....	12	Safety Tape/Paint .....	170
Back Up Alarms .....	190	Grilles, Lamp & Hood Hardware .....	76-84	Seat Belts.....	137
Battery Cable & Isolators .....	205	Handles & Latches, Side & Rear Door ..	94-113	Seats, Driver & Passenger .....	133-136
Bolts/Nuts/Washers .....	89	Headlight Assemblies/Bezels.....	76-83,227	Security Lock & Hasp .....	172
Brake & Wheel Hdw, GM/Workhorse ....	24-41	Heater Parts, All .....	149-165	Shift Cable, Automatic Trans.....	19
Brake & Wheel Hdw, Ford .....	47-56	Hinges, Rear Door.....	111	Shifter Boots.....	60
Brake & Wheel Hdw, Freightliner .....	64-67	Hood Hardware, Grilles & Lamps.....	76-84	Shocks.....	26,56,63,70
Brake & Wheel Hdw, Oshkosh & J-D .....	71-72	Horns.....	19	Stake Rack Connections/Latches .....	233
Brake & Wheel Hdw, International .....	73	Hydroboost.....	24,62,69	Starter.....	12
Brake Hdw, Sprinter & Isuzu.....	74	Ignition Coil.....	45	Steering Columns & Components.....	20-21
Brake Pads for Medium Duty Trucks.....	238	Insulation, Engine Cover .....	84	Steering Gear Boxes.....	22,49,60,69
Brake Caliper for Medium Duty Trucks....	236-237	Junction Boxes & Components.....	204	Steering Linkage, GM.....	26,31
Brake Controller .....	233	Key Blanks, Door & Ignition.....	90	Steering Linkage, Ford .....	50-51
Brooms/Squeegees.....	171	Lamps & Lighting, All .....	210-227	Steering Linkage, Freightliner .....	60
Bulbs, Auto & Service.....	208	Lashing/Rope Rings.....	233-234	Steering Pumps & Reservoirs.....	22,60
Bulk Head Door Hardware.....	114-115	Latches & Door Hardware.....	96-115	Steering Pressure Hoses.....	23
Bumpers, Front & Rear .....	2-5	Latches, Flush (Paddle).....	228-229	Steps, Retractable.....	4
Bumpers, Dock .....	5	Latches, Hood.....	77-84	Stereos.....	209
Bumpers, Hood & Engine Cover .....	76-84	License Plate, Recessed Boxes .....	4,226	Strip Curtains, Vinyl .....	168
Cable, Accelerator .....	19,68	Lift Gate Components .....	174-178	Strobe Lamps .....	213,224
Cable, Vernier Adj. Control.....	235	Loading Ramp.....	172-173	Sun Visors .....	138
Cab Protection .....	235	Manifolds, Intake & Exhaust, GM.....	16	Suspension Enhancement.....	75
Cargo Control.....	169-170	Manifolds, Exhaust, Ford .....	46	Suspension, Front/Rear, GM/Workhorse .....	26-41
Circuit Breakers.....	207	Master Cylinders.....	24,25,48,49,61,62,69	Suspension, Front/Rear, Ford.....	50-56
Clean-Up Products.....	171	Mats, Floor, Anti Fatigue.....	170	Suspension, Front/Rear, Freightliner .....	63-65
Clutch Spring & Fork.....	45	Mirrors & Mounting Hardware.....	179-191	Suspension, Front/Rear, Oshkosh,J-D .....	70
Condenser Fans .....	6-7	Mounts, Engine & Transmission .....	12,45,60,68	Switches & Pigtails .....	192-203
Control Cables.....	235	Mud Flaps .....	93	Tape, Electrical, Duct.....	92
Coolant Recovery Kit.....	7	Nutserts & Jacknuts.....	191	Todco Roll Up Door.....	116-122
Dock Bumpers .....	5	Oil Pans & Caps, GM/Workhorse .....	13	Towing & Trailer Accessories .....	230-235
Document Holder .....	170	Oil Pans & Caps, Ford .....	45	Trailer Connectors, Electrical.....	204-206
Door Hardware.....	94-115	Ordering Form.....	239	Transmission Shift Cable.....	19
Drill Bits .....	87	Paint, Touch Up.....	3	Transmission & Engine Cooler .....	7
Electrical Switches, Wire, Connectors..	192-206	Pedal Pads, Brake/Accelerator .....	19, 45	Transmission & Engine Mounts .....	12,45,60,68
Elevator Bolts.....	121	Pintle Hooks.....	230-231	Triangle Reflector Set.....	223
Emergency Drive Line Brake Parts .....	42,55	Quarter Turn Fasteners.....	89	Utility Hardware .....	228-238
Engine Cover Gaskets & Holddowns .....	84	Radiator & Condenser Fans .....	6-7	Vacuum Pump .....	12
Engine Freeze Plug Heaters.....	165	Radiators & Caps, GM/Workhorse .....	8-11	Vents & Fans .....	166-167
Engine/Transmission Oil Cooler .....	7	Radiators, Ford .....	43-44	Water Pumps .....	11,57
Engine &Transmission Mounts .....	12,45,60,68	Radiators, Freightliner, J-D & Oshkosh....	57	Weatherstrip, Side & Rear Door.....	99
Exhaust Systems, GM/Workhorse.....	17-18	Radiator, Sprinter.....	74	Wheel Chocks .....	168
Exhaust Systems, Freightliner.....	59	Ramp, Loading.....	172-173	Wheel & Brake Hardware .....	24-74
Fans, Ventilator & Circulating.....	166-167	Radios.....	209	Wheel Rims & Simulators.....	28,33,36,56,72
Fans, Condenser & Radiator .....	6-7	Rear Camera Video System.....	189	Whiting Roll Up Door .....	123-128
Flashers, Heavy Duty.....	207,222	Rear Ends & Components.....	37-41	Window Regulators.....	100-101
Fluorescent Lighting .....	210	Receiver Mounts, Tubes & Hitches .....	232	Windows, Sliding & Windshield.....	101-104
Freeze Plug Heaters .....	165	Reflective Safety Tape .....	223	Windshield Gasket & Tools .....	104
Fuel Tanks, Straps, Caps, Fill Tubes		Reflectors & Reflector Sets.....	223	Winterfront .....	76-79
& Line, GM.....	13-15	Rims & Wheel Simulators.....	28,33,36,56,72	Wiper Parts, All .....	138-148
Fuel Tanks & Caps, Ford.....	46	Rivets, Tools & Accessories.....	85-89	Wire & Connectors.....	199-206
Fuel Tanks & Caps, Freightliner.....	58	Roll Up Door, Whiting & Todco .....	116-132		