

## COUNTERBALANCE ASSEMBLY and CABLES that fit TODCO



**20-0962** - Counterbalance shaft 96" - cut to length

### 1-3/4" I.D. Counterbalance Spring with Winding Plugs

CB-25 ..... 25" Measure spring completely retracted and do not measure the winding plugs.  
 CB-32 ..... 32"  
 CB-38 ..... 38"  
 CB-39 ..... 39"  
 CB-40 ..... 40"  
 CB-42 ..... 42"  
 CB-43 ..... 43"  
 CB-44 ..... 44"



CB-48 ..... 48"  
 CB-52 ..... 52"  
 CB-57 ..... 57"  
 CB-60 ..... 60"  
 CB-45 ..... 45"  
 CB-46 ..... 46"

### 2-1/2" I.D. Counterbalance Spring with winding plugs

59076-19 ..... 19"  
 59076-22 ..... 22"



### INSIDE DOOR CABLES

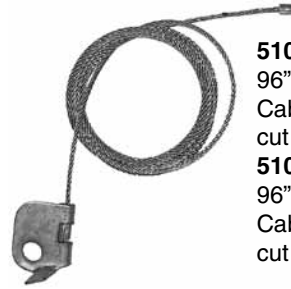

**51079-86-1**  
 96" Galvanized Cable Curbside, cut to length.  
**51079-86-2**  
 96" Galvanized Cable Roadside, cut to length.



51036-2

**51036-1 LH** Curbside  
**51036-2 RH** Roadside  
 Angle Bracket for Counterbalance



T1026

### OUTSIDE DOOR CABLES

Part #	Length	Eyelet	Type
<b>SSC-110</b>	110"	5/16"	Stainless
<b>51044-110</b>	110"	5/16"	Galvanized
<b>SSC-7125</b>	125"	7/16"	Stainless
<b>GSC-5130</b>	130"	5/16"	Galvanized
<b>SSC-5130</b>	130"	5/16"	Stainless

T-1026 - Cable Anchor Kit



**SPRING ANCHOR PLUG**  
**51043** - for 1-3/4" I.D. Spring  
**59024** - for 2-1/2" I.D. Spring



**SPRING WINDING PLUG**  
**59158** - for 1-3/4" I.D. Spring  
**59159** - for 2-1/2" I.D. Spring



**80023** - Spacer Washer - Drum, Inside Cable Door



**20-0972** LH Bearing, Inside Cable Door



### CABLE DRUM



**59129-1** - LH (Curbside) to 105" door height  
**59129-2** - RH (Roadside) to 105" door height  
**59157-3** - LH (Curbside) 105" to 120" door height  
**59157-4** - RH (Roadside) 105" to 120" door height



**20-0961** Bearing Assy; LH & RH end, Outside Cable Door



**20-0963** Bearing Assy. Center Support or RH. Inside Cable Door



**69353** - Head Protector



### TODCO LUBE

**39000-1016**  
 Gallon

**39000-1008**  
 12oz. Spray

**Will not attract dirt like other lubricants.**

**HORIZONTAL AND VERTICAL TRACKS ARE SPECIAL ORDER AND TAKE APPROX. 3 WEEKS. HAVE YOUR SERIAL NUMBER READY WHEN YOU ORDER. SERIAL NUMBERS ARE LOCATED ON THE METAL TAG ATTACHED TO THE INSIDE UPPER RIGHT HAND CORNER OF THE TOP PANEL. (Standing inside the unit facing out)**

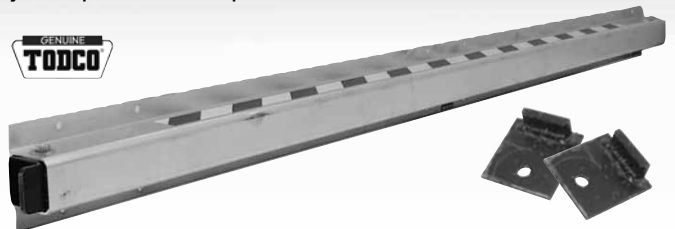

**39-582** - Load Bar Assembly complete with 2 catch plates and enough camtainer fasteners to mount load bar to door.

**ROLL-UP DOOR**

## HINGES, ROLLER HOLDERS and ROLLERS that fit TODCO



**69432**  
Base -  
Adjustable  
Top Fixture



**69431**  
Slide -  
Adjustable Top  
Fixture

**69433**  
Complete Adjustable Top Fixture with  
slide and base (69431 & 69432)



**61196**  
Center Hinge  
**70-238**  
Heavy Duty Center Hinge



**69035**  
End Hinge  
**70-236**  
Heavy Duty End Hinge



**69977**  
Plastic Sleeve only  
**69981**  
End Hinge with  
plastic sleeve



**70311**  
End Hinge with  
Removable Roller  
Cover, Black.  
**70309**  
Cover Only  
This hinge allows you to  
replace the roller without  
removing the hinge.



**61352**  
Bottom  
Roller  
Holder



**NEW** **70344-1**  
**70344-1** - LH Bottom Fixture Base  
**70344-2** - RH Bottom Fixture Base  
**70309** - Roller Cover only



**70309**

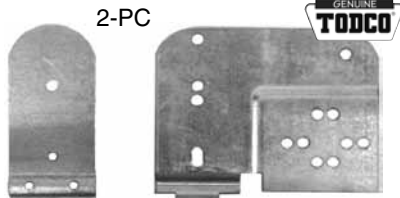

2-PC

### 1-1/8" Polar Guard Door Bottom Fixtures

**70082-1** - LH Bottom Fixture, Curbside  
**70082-2** - RH Bottom Fixture, Roadside



**70171**  
Top Panel  
Roller Holder

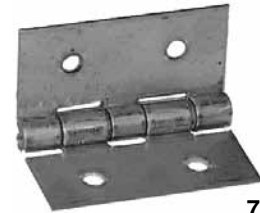

**70168**  
Center Hinge



**11-17149**  
Splined Carriage  
Bolt - 1/4" x 1-1/2"



**70188**  
End Hinge with  
plastic insert.  
Insert may be  
installed but can  
be removed and  
reversed for LH or  
RH side of door.



**70169**  
Bottom Roller  
Holder with  
plastic insert.  
Insert may be  
installed but can  
be removed and  
reversed for LH  
or RH side of  
door.



## QUICKLY REPAIR DAMAGED DOOR TRACK

Repair your track quickly and easily while on the truck. Use the 1" or 2" dolly to hammer through crushed track; use the slot to tweak the edges of track back into shape.



**NEW**  
**20-2311**  
1" Tweakster  
Dolly tool.  
Repair 1"  
track



**NEW**  
**20-2312**  
2" Tweakster  
Dolly tool.  
Repair 2"  
track

**80020**  
Spacer Washer - Mounts  
on Roller Shaft



Use only at the upper most and lower most hinge locations. They help square the door for smooth operation.

This quality roller has been proven to last longer than any other Todco or aftermarket roller!



**70305**  
1" Precision Machined  
Roller, **STEEL**



**69983**  
1" Roller,  
**BLACK NYLON**



**T-9162**  
1" Sealed Roller,  
**STEEL**

ROLL-UP DOOR

## BOTTOM PANEL HARDWARE that fit TODCO

### TODCO ROLL-UP DOOR HANDLE



**69571**  
Maximum Security  
Lock Assembly

**69572**  
Keeper  
Assembly



**M-1261**  
Pull Strap  
One Yard (36")



**69832**  
Pull Strap  
Retainer



**20-0598**  
Lift Handle



**T1026**  
Cable Anchor Kit,  
(Clevis Pin, Washer, Cotter)

### TODCO ROLL-UP DOOR SAFETY HANDLE (Will unlock even if padlocked)



This emergency escape latch releases outside hook by pulling inside lever. When hook is disengaged door can be lifted even if padlocked.

**Latch falls apart each time inside release is used.**

**69-807** - Maximum Security Latch with Inside Release Handle (keeper not included)

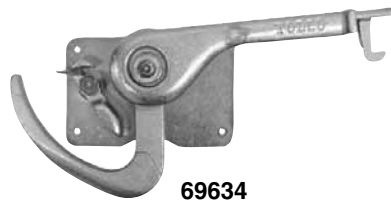

**69634**  
Maximum Security  
"J" Latch Only

**69716-1** - Maximum Security "J" Lock with Lock Box and Strike, Complete (69634, 69714-1, 69341)



Front View

**70263**  
Maximum Security "J" Latch with  
inside release handle

Back View showing  
inside release  
handle

**NEW**  
**69816**

Inside release handle only for 70263

**Popular on Fedex Ground Vehicles with Lock Box with Best Cylinder shown directly below**

### TODCO ROLL-UP DOOR SAFETY HANDLE with KEEPER (Will not unlock if padlocked)

Inside Release



**Popular on  
Fedex Ground  
Trucks**

Pull inside lever to turn hook on outside. Turn inside finger knob to turn keeper. Will not unlock if padlocked.

**70-219** - Maximum Security Latch with Inside Release Handle & Inside Release Keeper.

The Lock Boxes shown below can be used with either  
Maximum Security "J" Latch Shown above.



**69711**  
Cylinder for Lock Box Only  
(Strattec Cylinder)



**69670** - Best/  
Liberty Cylinder  
Retainer



**69011** - Best Cylinder  
Housing w/spacer



**20-0752**  
Catch Plate,  
Flat Style



**20-0755**  
Catch Plate,  
Box Style,  
Steel



**20-553**  
Catch Plate,  
Aluminum



**20-557**  
Catch Plate,  
Aluminum



Fits Utilimaster

**NEW**  
**20-9173**  
Catch Plate



Rear View



**69714-1**  
Lock Box Housing  
w/Strattec Cylinder



**29-709** - Best  
Cylinder Core w/ (1)  
install key and (2)  
operating keys



**29-713** Two Cyl-  
inder Cores (Keyed  
alike) Includes: (1)  
install key and (4)  
operating keys

(Cylinder not included)

**29-708** - Key Blank  
only

### Replacement Parts for above Lock Boxes



**69713**  
Replacement  
Spring for Lock Box



**69710**  
Replacement Catch  
for Lock Box



**69669**  
Replacement Shoulder  
Bolt for Lock Box

ROLL-UP DOOR

## SLAM LATCH HARDWARE that fit TODCO

 <p><b>69648-4</b> Slam Lock Assembly for keyed or padlock handle. (Handle sold separately)</p> <p><b>69648-5</b> Slam Lock Assembly for Best Cylinder (Best cylinder, sold separately)</p>	 <p><b>25-125</b> Locking Handle</p>	 <p><b>61375</b> Guide Pin</p>	 <p><b>WELD IN TYPE</b> <b>61379</b> Floor Catch Plate (no holes)</p>  <p><b>BOLT ON TYPE</b> <b>69075</b> Floor Catch Plate (with holes)</p>  <p><b>69-076</b> Catch Plate Reinforcement. Fits Grumman/Morgan Olson only</p>
 <p><b>69991</b> Cylinder Assy &amp; Mtg. Plate for 69652 (Uses Chicago Cylinder)</p>	 <p><b>69799</b> Chicago Cylinder Only</p>  <p><b>69800</b> Plate only for Chicago Cylinder 69652</p>	 <p><b>61450</b> Best Cylinder Plate for 69648-5</p>	   <p><b>69011</b></p>  <p><b>29-708</b> <b>29-709</b></p>
 <p><b>70090</b> Center Control used with Best Cylinder <b>69007</b> Cam Only</p>	 <p><b>69959</b> Center Control used with 69991 Cylinder Assy.</p>	 <p><b>T-0191</b> Paddle Handle Latch Center Mechanism <b>4901-51</b> Lock Cylinder</p>	<p><b>69011</b> Best Cylinder Housing with spacer, for Todco Doors <b>69962-2</b> 1/2" Cylinder Spacer Only <b>29-709</b> One Cylinder Core with (1) install key and (2) operating keys <b>29-713</b> Two Cylinder Cores (Keyed alike) Includes: (1) install key and (4) operating keys <b>29-708</b> - Key Blank</p>
 <p><b>70102</b> 45" Lock Cable with Floating Stop</p>	 <p><b>69951</b> Lock Catch <b>69953-1</b> LH Mounting Plate, Curb Side (shown) <b>69953-2</b> RH Mounting Plate, Road Side</p>	 <p><b>20-0776</b> Safety Chain Lock <b>20-0770</b> Safety Chain</p>	 <p><b>K-4168X</b> Push Button Handle <b>20-7011</b> Mount plate with threaded inserts <b>97-438-P</b> 10-24x1 Mount Screw</p>
 <p><b>70472</b> - End Latch, Universal, fits LH or RH, Replaces 70097-1 &amp; 2</p>  <p><b>69943</b> - Spring for 70472 End Latch</p>	 <p><b>70170-1</b></p>  <p><b>70170-2</b></p>  <p><b>70101</b> Spring Only</p>	 <p><b>39550-1</b></p>  <p><b>39550-2</b></p> <p><b>39550-1</b> - LH Latch Assy, Curbside <b>39550-2</b> - RH Latch Assy, Roadside</p>	

**ROLL-UP DOOR**

## TOP, BOTTOM AND SIDE SEALS AND RETAINERS that fit TODCO

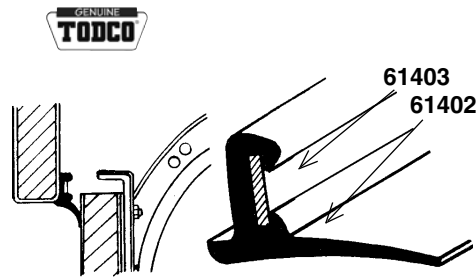

**61403** - 90" Retainer for Header Seal  
**61402** - 96" Header Seal

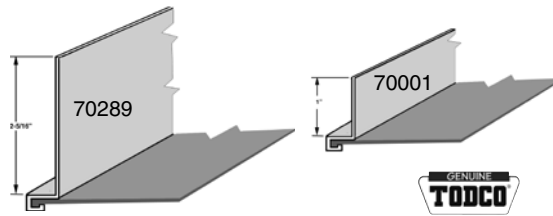

**70289** Alum. Retainer and Header Seal, 96" L, 2-5/16" flange. Used on extruded aluminum doors  
**70001** Alum. Retainer with Header Seal, 96" L, 1" aluminum flange.



**69790** - 96" Retainer for Header Seal

**69718** - Rubber Header Seal only, 96"L

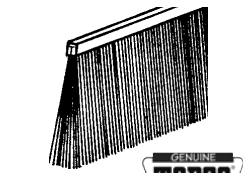

**70255**  
96" Top Brush Seal, 1-1/2"

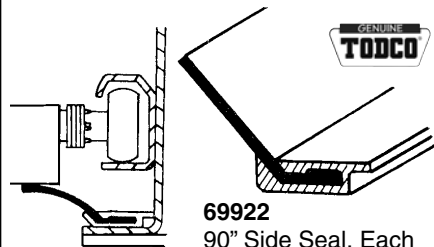

**69922**  
90" Side Seal, Each

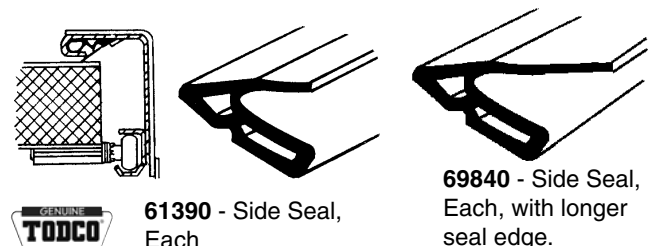

**61390** - Side Seal, Each

**69840** - Side Seal, Each, with longer seal edge.

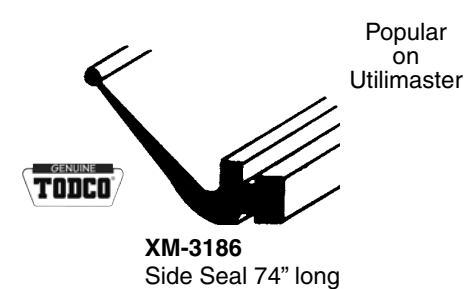

**XM-3186**  
Side Seal 74" long

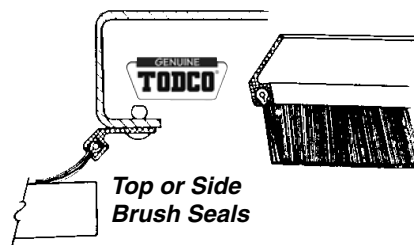

Top or Side Brush Seals

**70231** - 96" Brush Seal, 1" Brush  
**NEW 70272** - 96" Brush Seal, 1-1/2" Brush

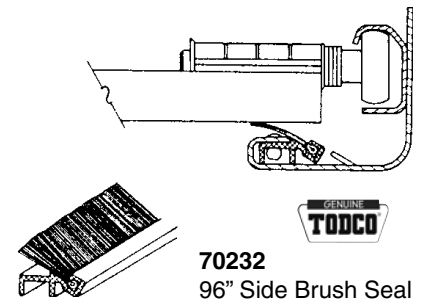

**70232**  
96" Side Brush Seal

### 3/4" Bottom Seal and Retainer

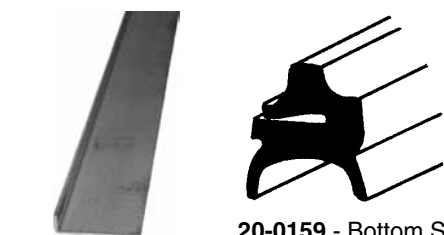

**20-0145** - Retainer and kick plate for 20-0159

**20-0159** - Bottom Seal, original style, 94"  
**20-255** - Bottom Seal, 75 foot roll

### Newer Style 3/4" Bottom Seal

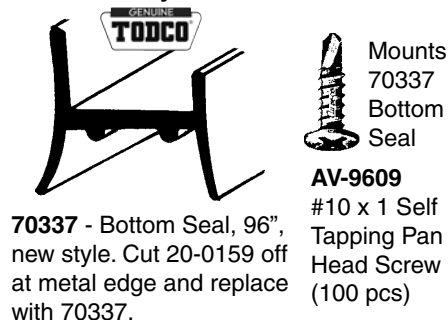

**70337** - Bottom Seal, 96", new style. Cut 20-0159 off at metal edge and replace with 70337.

Mounts **70337** Bottom Seal  
**AV-9609** #10 x 1 Self Tapping Pan Head Screw (100 pcs)

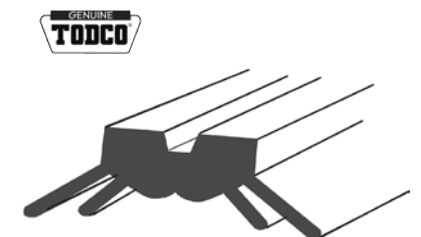

**70354**  
Bottom Seal, 61.5" long (used on Fleetstar Door) (alum. door)

### Polar Guard Door Bottom Seal and Retainer



**69110-2712** Bottom Seal Retainer, 84-3/4" L

**70084-2827** Bottom Seal

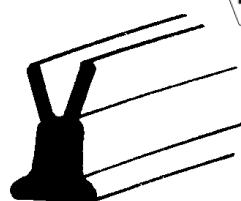

**70180**  
Joint Seal, 51"



**69242** - Bottom Seal, 10 ft long

ROLL-UP DOOR

## TOP, INTERMEDIATE AND BOTTOM UNIVERSAL ROLL-UP DOOR PANELS

Mill Supply carries universal door panels to fit 99% of all step vans with Todco doors. These panels are gray in color, have a 92" width, and can be cut at each end to provide the correct length. When cutting panels to a smaller width, to ease your installation, Mill Supply has had the inside routing edge lengthened for the knuckle portion of the end hinges. **Special order panels and complete doors are available, see pages 129-132. Special orders take approximately 4 weeks.**

The top panel is available in a 92" width and a 15" height. If your top panel varies from the size we carry the top edge can be cut off to the correct height. The panels can also be cut at both ends to meet your correct width (cutting the same amount on each end) Additional routing has been provided on the inside bottom to ease installation of end hinges.

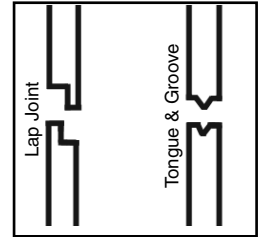

Our panels are Tongue and Groove style and cannot be mixed with the Lap Joint Style

### WOOD TOP PANEL

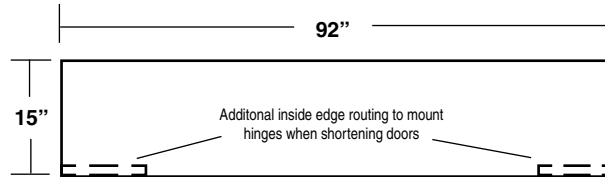

TP-15 - 15" x 92" Top Panel

### WOOD INTERMEDIATE PANELS

Intermediate panels are available in a 92" width and an 11" or 15" height. If your intermediate panel varies from the sizes we carry the panels can be cut at both ends to meet your correct width (cutting the same amount on each end) Additional routing has been provided on the inside top and bottom to ease installation of end hinges.



IP-11 - 11" x 92" Intermediate Panel

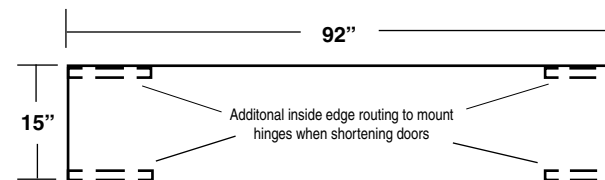

IP-15 - 15" x 92" Intermediate Panel

Bottom panels are available in a 92" width and an 11" or 15" height. If your bottom panel varies from the sizes we carry the panel can be cut at both ends to meet your correct width (cutting the same amount on each end) A metal cutting blade may be needed to cut the bottom angle mounted on panel. Additional routing has been provided on the inside top to ease installation of end hinges.

### WOOD BOTTOM PANELS

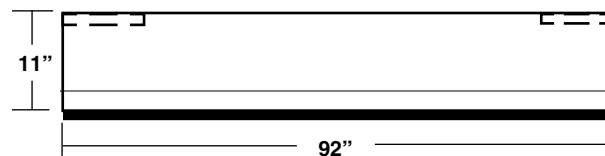

BP-11 - 11" x 92" Bottom Panel

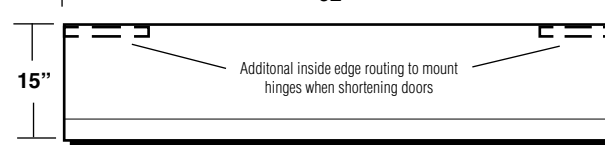

BP-15 - 15" x 92" Bottom Panel

#### HARDWARE INCLUDED ON BOTTOM PANEL:

- Bottom Seal
- Bottom Angle

#### MOUNTING HARDWARE FOR ROLL-UP DOOR HANDLES



AV-11331-P



97-438-P

- 97-438P ..... 10-32 x 1" Phillip head screw, each  
 97-438 ..... 10-32 x 1" Phillip head screw, 50pcs  
 AV-11331-P ..... 10-32 T-Nut, each  
 AV-11331 ..... 10-32 T-Nut, 50pcs

#### 1/4" ELEVATOR BOLTS AND NUTS



- 20-001 - 1" Elevator Bolt  
 20-114 - 1-1/4" Elevator Bolt with nut  
 20-112 - 1-1/2" Elevator Bolt with nut  
 20-134 - 1-3/4" Elevator Bolt  
 20-002 - 2" Elevator Bolt  
 20-212 - 2-1/2" Elevator Bolt  
 20-003 - 3" Elevator Bolt



M-1478  
1/4" Hex Nut  
(100 pcs)



M-1576  
1/4" Kep Nut  
with lock washer  
(100 pcs)



11-17149  
Splined Carriage Bolt  
1/4" x 1-1/2"

We also carry other style doors and panels, see the following page.

With Todco, there are a number of styles of doors to choose from. When replacing an entire door or when used in a new application choose the door that best matches your needs.

TO ORDER A COMPLETE DOOR SEE PAGES 129-132

### PLYWOOD DOORS WITH TOUGHSELL™

Plywood is the material of choice for the majority of dryfreight overhead doors. It's strong, durable and flexible.

TODCO uses patented 3/4", 7-ply, premium-grade plywood for the foundation of their doors. It has a hardwood outer veneer that virtually eliminates wood grain "telegraphing," giving a smoother, more uniform look that lasts.

Their revolutionary TOUGHSELL™ system is a multi-layered formulation of liquid polymers that are specifically designed to work together on wood substrates, and provide a state-of-the-art defense against moisture, abrasion, temperature extremes, harsh chemicals, even UV damage – in short, just about anything you can run into.



### WEATHERTITE™ POLYCOMPOSITE DOORS

With the innovative WeatherTite™ overhead door, TODCO is extending what you can expect from your trucks and trailers. It's a tough and attractive door choice crafted from a polycomposite material that will let you shed any worries about the greatest threat to door durability and life: water penetration.

The WeatherTite door is impervious to moisture, so it eliminates the problems of swelling, warping, finish delamination and rotting. Plus, it's rugged enough to stand up to the hard knocks and day-in-and-day-out challenges every fleet faces. And it's crafted with the extra-quality touches and rugged features that come from TODCO's long leadership and experience.



### TODCO DUALTIGHT™ ALUMINUM CLAD DOOR

Like the tough, long-lasting advantages of TODCO plywood doors? Like the added weather-resistance and smooth, good looks of aluminum? TODCO has your door: the aluminum-clad DualTight™ overhead door. It's a combination that lets you get the most out of both plywood and aluminum.

At the core, you have the strength and durability of 3/4" or 1" marine-type plywood. Then over the exterior face and joints of the door, TODCO secures a .024 mm aluminum skin. The skin can be pre-painted to color-match your trucks; and with no grain transfer, it gives you a smoother, better looking finish. The inside surface gets the added protection of ToughShell™ primer. Not only does this combination work longer and look more attractive, but it also works harder. You get all the operational advantages the industry has come to expect from TODCO. The DualTight aluminum-clad door offers all-around confidence.

### ROLL-UP SHUTTER DOORS

Every component of Todco's roll-up shutter doors adds to their durability, quality and to the savings they deliver over time.

Fabricated of tough, attractive anodized aluminum or bright-brushed aluminum. Also available in mill finish aluminum versions which can be painted to match your vehicle.

The door face is flat, with nothing to obstruct its attractive look.

Panels are constructed with nylon end-guides for smooth, quiet operation without continual lubrication.

Counterbalance assembly rolls door in a coil.

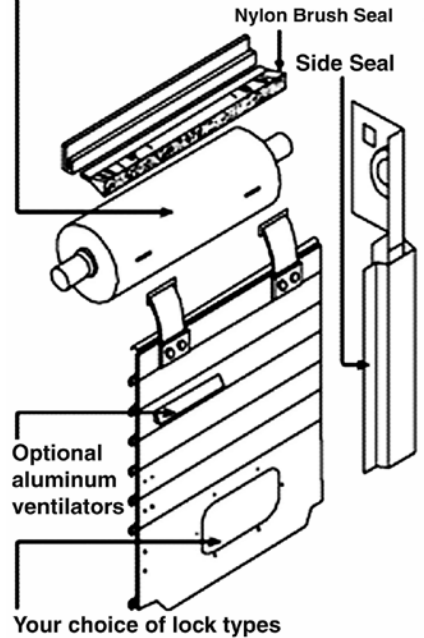

As an option each panel can be intersealed to lock out the effects of even the worst weather, such as freezing rain and sub-zero temperatures.

Rubber strip on the bottom panel creates a seal that acts like a sound-absorbing buffer.

Low temperature side seals around the door perimeter withstand the effects of weather and aging which can destroy ordinary seals.

Standard header/counterbalance design—where the door coils up into the header—requires as little as 5" of headroom, and takes up no usable space.

The TODCO door's front/roll configuration can be customized to efficiently fit most application.

The TODCO roll-up shutter door can be easily customized to fit a variety of uses. It has proven itself in applications as diverse as these:

- Truck bodies (including utility and service body trucks)
- Lube trucks used to service off-road equipment
- Tractors
- Specialty furniture
- Interior doors
- Airline refuelers
- Tool compartments
- Carnival trailers
- Pull trailers

ROLL-UP DOOR

## COUNTERBALANCE ASSEMBLY AND CABLES that fit WHITING



**W-2528**  
Counterbalance Shaft



**20-2017**  
Cable Drum, Roadside  
(with Bearings)  
**20-2016**  
Cable Drum, Curbside  
(with Bearings)

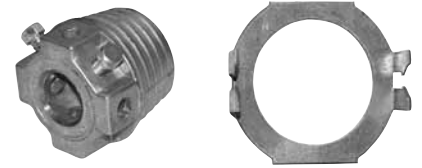

**20-2018**  
Winding Cone  
for Spring

**W-2522**  
Thrust Washer



We Stock	Side	I.D.	Wire Size	Length
<b>CS-14815</b>	Curbside	2-3/16"	.148	15"
<b>RS-14815</b>	Roadside	2-3/16"	.148	15"
<b>CS-14817</b>	Curbside	2-3/16"	.148	17"
<b>RS-14817</b>	Roadside	2-3/16"	.148	17"
<b>CS-16219</b>	Curbside	2-3/16"	.162	19"
<b>RS-16219</b>	Roadside	2-3/16"	.162	19"
<b>CS-16220</b>	Curbside	2-3/16"	.162	20"
<b>RS-16220</b>	Roadside	2-3/16"	.162	20"
<b>CS-17120</b>	Curbside	2-3/16"	.171	20"
<b>RS-17120</b>	Roadside	2-3/16"	.171	20"
<b>20-951</b>	Curbside	2-3/16"	.177	23"
<b>20-950</b>	Roadside	2-3/16"	.177	23"

For sizes not listed the following can be ordered.  
**W-2704** - Spring, Roadside (LH Wound)  
requires door serial number to order  
**W-2705** - Spring, Curbside (RH Wound)  
requires door serial number to order

### Spring Kit



**Kit Includes**

- 20" Spring
- Cable Drum
- Winding Cone
- Thrust Washer

**20-940** - Spring Assembly Roadside  
**20-941** - Spring Assembly Curbside

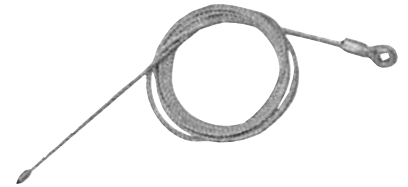

**SSC-5130**  
130" Stainless Steel  
Cable, 5/16" Eyelet  
**GSC-5130**  
130" Galvanized Steel  
Cable, 5/16" Eyelet  
**GSC-7130**  
130" Galvanized Steel  
Cable, 7/16" Eyelet

**W-2523**  
Balancer Bracket,  
Curbside  
**W-2524**  
Balancer Bracket,  
Roadside  
**W-2525**  
Center Bracket  
**W-2526**  
Clamp

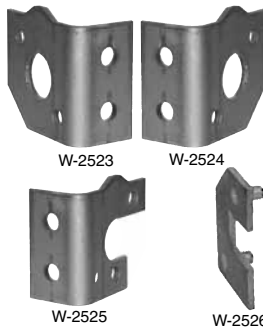

**20-900**  
Spring Silencer Boot, 24-1/4" long.  
Use with 20" springs  
**20-901**  
Spring Silencer Boot, 27-1/4" long.  
Use with 23" springs  
*Other lengths available, order 4-1/4" longer  
than spring.*



**W-83**  
Head Protector  
for end of track

## 1/4" ELEVATOR BOLTS



- 20-001** - 1" Elevator Bolt
- 20-114** - 1-1/4" Elevator Bolt with nut
- 20-112** - 1-1/2" Elevator Bolt with nut
- 20-134** - 1-3/4" Elevator Bolt
- 20-002** - 2" Elevator Bolt
- 20-212** - 2-1/2" Elevator Bolt
- 20-003** - 3" Elevator Bolt

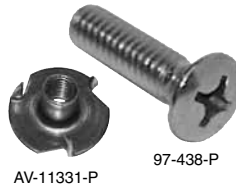

**M-1576** 1/4"  
Kep Nut with lock  
washer (100 pcs)



**M-1478** 1/4" Hex  
Nut (100 pcs)

### MOUNTING HARDWARE FOR ROLL-UP DOOR HANDLES

- 97-438-P** 10-32 x 1" Phillip head screw, each
- 97-438** ..... 10-32 x 1" Phillip head screw, 50pcs
- AV-11331-P** ..... 10-32 T-Nut, each
- AV-11331** ..... 10-32 T-Nut, 50pcs

**Whiting Lap-Joint Door Panels are also available. Have your serial number ready with the size and style of the panels you are ordering.**

**To order a complete door  
see pages 129-132**

## HINGES, ROLLER HOLDERS AND ROLLERS that fit WHITING



**W-1726**  
Top Roller Slide



**W-1264**  
Top Roller  
Base with  
Hardware



**NEW**  
**W-15886**  
Top Roller  
Fixture



**T-9162**  
1" Sealed Roller, *STEEL*

**W-6944** - Adjustable Top Fixture, includes  
W-1726 & W-1264



**20-2084**  
Center  
Hinge



**W-1207**  
End Hinge without  
Roller Cover



**W-1208**  
End Hinge Roller  
Cover Only



**20-2003**  
2" Steel Roller

**W-1209**  
End Hinge Complete (Incl. W-1207 & W-1208)

### Lite Weight Door Roller Carrier Assy.



**W-7069-2**  
Roadside Panel Repair Kit  
**W-7069-1**  
Curbside Panel Repair Kit  
**W-5728**  
Roller Carrier Only

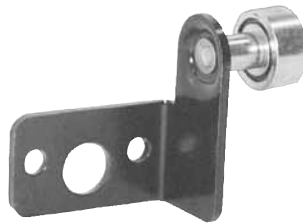

**W-3295**  
Roller with Bracket, Curbside

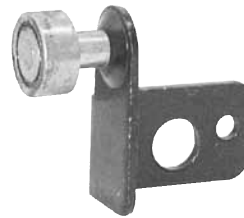

**W-3296**  
Roller with Bracket, Roadside



**20-2771**  
2" Nylon Roller



**69983**  
1" Nylon Roller



**W-1021**  
Bottom Roller Shaft Cover



**W-1370**  
Bottom Roller Base



**W-7181**  
Bottom Roller Bracket



**TODCO  
LUBE**  
**39000-1016**  
Gallon  
**39000-1008**  
12oz. Spray

**ROLL-UP DOOR**

## BOTTOM PANEL HARDWARE that fits WHITING



**W-3223**  
Lock Assembly with inside release for 3/4" Dry Freight Door, less keeper

**W-7535-1**  
Keeper for W-3223



**20-0770**  
Safety Chain



**20-0776**  
Safety Chain Lock



**W-1715**  
Grab Handle

Will work with either  
**20-077** or **W4077**



**W-2804**  
Catch Plate, Steel



**20-553**  
Catch Plate, Aluminum

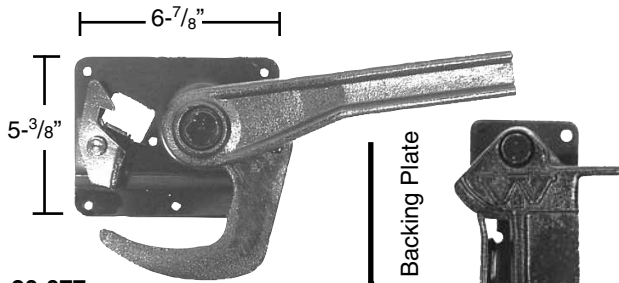

**20-077**  
Lock Assembly with offset at bottom edge of mounting plate, less keeper

Offset Backing Plate



**W-2766**  
Keeper

**W-23**  
Black Pull Down Strap, 19" Long x 2" Wide  
**20-219**  
White Pull Down Strap, 19" Long x 2" Wide



**W-9723-50** **NEW**  
**Whiting Roll Up Door Strap** 60" long with Inside door bracket. 2" webbing with loop sewn in end for Footman bracket.

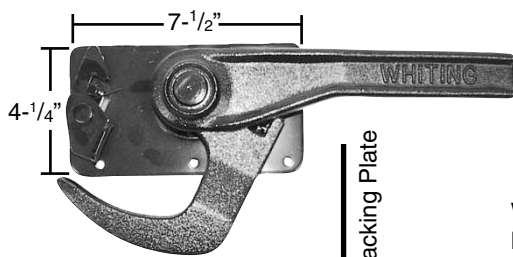

**W-4077**  
Latch for use with Lock Box

Flush Backing Plate

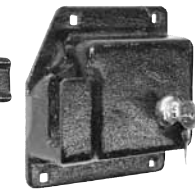

**W-6571** - Lock Box with **Standard Cylinder**



**20-362**  
**Standard Cylinder** with key



**WDC-55** Cylinder Housing for Best Lock, (Brass)  
**29-709** One Cylinder Core with (1) install key and (2) operating keys  
**29-713** Two Cylinder Cores (Keyed alike) Includes: (1) install key and (4) operating keys  
**29-708** - Key Blank

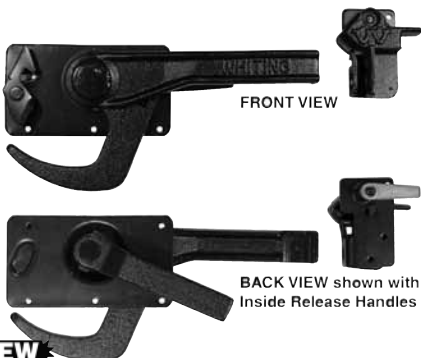

**NEW**  
**W-7142** - Latch w/Inside Release with Keeper. Popular on Fedex Ground Trucks

**NEW**  
**20-9173** - Catch Plate

### Conversion Kit for Cam Action Latch on Light Weight Door

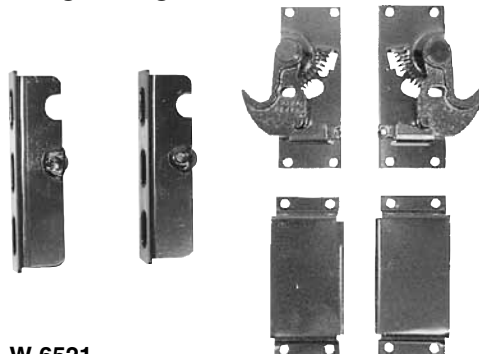

**W-6521**  
Latch Assembly, Roadside & Curbside (use existing rods)



**20-200**  
Spring only for W-6521





















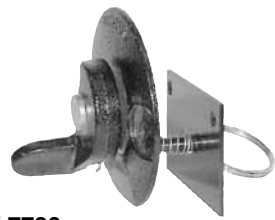

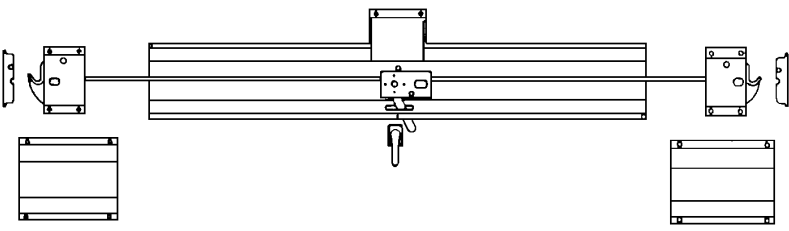

**W-2342**  
Old Style Latch Strike

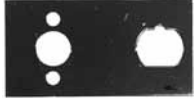

**W-5793**  
Outside "L" Handle Mounts from inside.

ROLL-UP DOOR

## SLAM LATCH HARDWARE that fits WHITING

<p><b>W-2424</b> Center Mechanism Plate Assy. for Best Cylinder W-5794 Base Plate Only for W-2424</p>  <p><b>WDC-55</b> Cylinder Housing, (Brass) <b>29-709</b> - Cylinder Core <b>29-708</b> - Key Blank</p>	 <p><b>25-113</b> Non Locking Handle with Blind Mount</p>	 <p><b>W-4695</b> (shown) LH Latch Assembly Curbside, Offset Base <b>W-4696</b> RH Latch Assembly Roadside, Offset Base</p>	 <p><b>20-200</b> Spring Only for W-4695 &amp; W-4696</p>		
<p><b>W-6</b> Washer</p>  <p><b>W-7976</b> Bottom Plate</p>  <p><b>W-6089</b> Center Mechanism Actuator</p> 	 <p><b>W-6467-1</b> Latch Plate Catch</p>	 <p><b>W-7730</b> Safety Latch with inside Release</p>	 <p><b>20-0259</b> Plastic Covered Cable for Safety Latch Mechanism</p>		
<p><b>W-7990-XXX</b> Latch Assembly with cover plates, rods and panel (Requires Door Serial Number) <b>W-7990-L-XXX</b> Latch Assembly with rods only, no panel (Requires Door Serial Numbers)</p>			 <p><b>W-2341</b> Inside Release Handle Reinforced</p>		
 <p><b>W-6598</b> LH Latch, Curbside Flat Base</p>  <p><b>W-6599</b> RH Latch, Roadside Flat Base</p>	 <p><b>W-8369</b> LH Latch, Curbside Offset Base</p>  <p><b>W-8368</b> RH Latch, Roadside Offset Base</p>	 <p><b>W-8380</b> Striker</p>	 <p><b>W-2159</b> Mounting Plate</p>	 <p><b>W-5794</b> Base Plate</p>	 <p><b>W-5762</b> Inside Handle</p>
 <p><b>W-5894</b> Lock Dog</p>		 <p><b>W-5895</b> Cylinder Plate</p>			

**ROLL-UP DOOR**

### QUICKLY REPAIR DAMAGED DOOR TRACK

**HORIZONTAL AND VERTICAL TRACKS ARE SPECIAL ORDER AND TAKE APPROX. 3 WEEKS. HAVE YOUR SERIAL NUMBER READY WHEN YOU ORDER. SERIAL NUMBERS ARE LOCATED ON THE METAL TAG ATTACHED TO THE INSIDE UPPER RIGHT HAND CORNER OF THE TOP PANEL. (Standing inside the unit facing out)**



Repair your track quickly and easily while on the truck. Use the 1" or 2" dolly to hammer through crushed track; use the slot to tweak the edges of track back into shape.

## PARTS THAT FIT WHITING GENERAL PURPOSE DOORS



**20-0962** - Counterbalance shaft 96" - cut to length

### 1-3/4" I.D. Counterbalance Spring with Winding Plugs

- CB-25** ..... 25" Measure spring completely  
**CB-32** ..... 32" retracted and do not measure  
**CB-38** ..... 38" the winding plugs.  
**CB-39** ..... 39"  
**CB-40** ..... 40"  
**CB-42** ..... 42"  
**CB-43** ..... 43"  
**CB-44** ..... 44"  
**CB-45** ..... 45"  
**CB-46** ..... 46"  
**CB-48** ..... 48"  
**CB-52** ..... 52"  
**CB-57** ..... 57"  
**CB-60** ..... 60"



**T-1026**



### OUTSIDE DOOR CABLES

Part #	Length	Eyelet	Type
<b>SSC-110</b>	110"	5/16"	Stainless
<b>51044-110</b>	110"	5/16"	Galvanized
<b>SSC-7125</b>	125"	7/16"	Stainless
<b>GSC-5130</b>	130"	5/16"	Galvanized
<b>SSC-5130</b>	130"	5/16"	Stainless

**T-1026** - Cable Anchor Kit

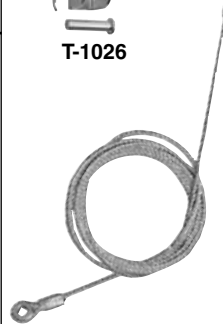

**SPRING ANCHOR PLUG**  
**51043** - for 1-3/4" I.D. Spring  
**59024** - for 2-1/2" I.D. Spring



**SPRING WINDING PLUG**  
**59158** - for 1-3/4" I.D. Spring  
**59159** - for 2-1/2" I.D. Spring



**80023** - Spacer Washer - Drum, Inside Cable Door



**20-0972** LH Bearing, Inside Cable Door

### CABLE DRUM



- 59129-1** - LH (Curbside) to 105" door height  
**59129-2** - RH (Roadside) to 105" door height  
**59157-3** - LH (Curbside) 105" to 120" door height  
**59157-4** - RH (Roadside) 105" to 120" door height



**20-0961** Bearing Assy; LH & RH end, Outside Cable Door



**20-0963** Bearing Assy. Center Support or RH. Inside Cable Door



**69432** Base - Adjustable Top Fixture



**69431** Slide - Adjustable Top Fixture

**69433** Complete Adjustable Top Fixture with slide and base (69431 & 69432)



**61196** Center Hinge  
**70-238** Heavy Duty Center Hinge



**69035** End Hinge  
**70-236** Heavy Duty End Hinge



**61352** Bottom Roller Holder



**T-9162** 1" Sealed Roller, STEEL



**70305** 1" Precision Machined Roller, STEEL

ROLL-UP DOOR

**TOP, BOTTOM AND SIDE SEALS that fit WHITING**

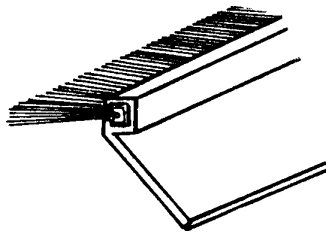

**W-5890**  
Side Seal, Brush Type, 96"

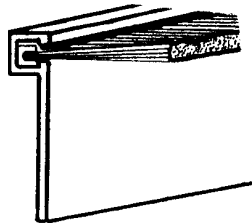

**W-5886**  
Top Brush Seal Assembly, 96"  
**W-5838** - Alum. Retainer  
**W-5843** - Brush Seal

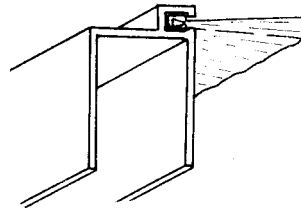

**W-7841**  
Top Brush Seal Assembly, 96"  
*Includes:*  
**W-5871** - Alum. Retainer, 96"

**To order a complete door see pages 129-132**

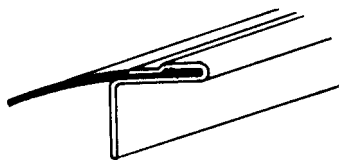

**W-26**  
Top Seal, 96"

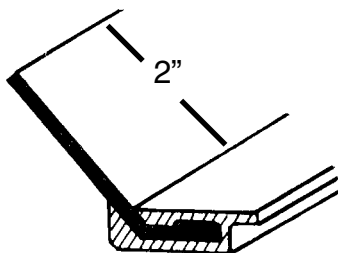

**W-3766** - Side Seal, Each, 90"

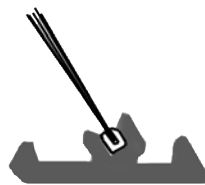

**NEW**  
**W-6589** - Side Brush Seal with gray vinyl retainer. Used on refrigerator bodies. 96"



**W-2445**  
Side Seal, 96"

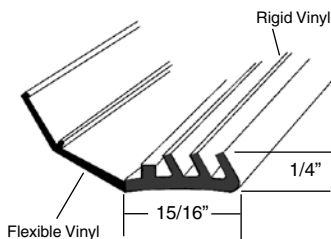

**W-16**  
Side Seal with 1/4" track, 93"

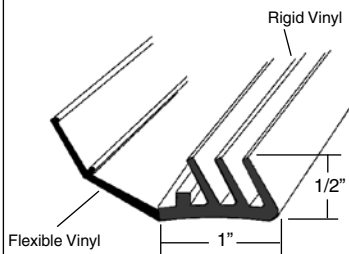

**W-5377**  
Dual durometer side seal, for track assy with 1/2" track spacing. 96"

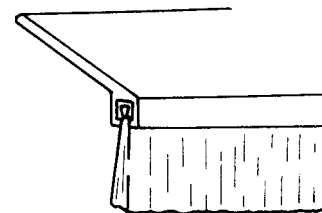

**W-7843**  
Side Brush Seal Assy, 84"  
*Includes:*  
**W-6924** - Alum. Retainer  
**W-7840** - Clear Brush Side Seal, 1"

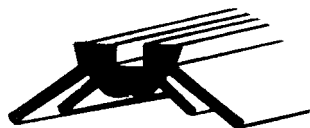

**W-5735**  
Bottom Seal, 96"

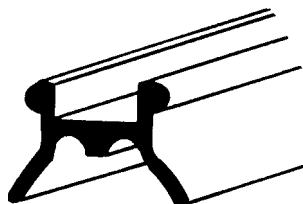

**W-2088**  
Bottom Seal, 91"



**W-1676**  
Bottom Seal, 96"

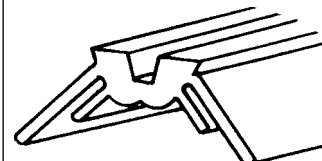

**W-7812**  
Bottom Seal, white, 60"

**ROLL-UP DOOR**

**Fill in the dimensions below and answer the questions on the following 3 pages when ordering individual door panels or a complete new door. Mail or Fax this page with pages 130-132 (page 132 must be signed) to:**

**MILL SUPPLY, INC.**  
 PO BOX 28400  
 CLEVELAND, OH 44128-0400  
 FAX (888) 781-2700

See page 122 for a variety of styles of Todco doors to choose from.

Make copies of pages 129-132, you may need an original order form for another door in the future.

Overall Height of Door \_\_\_\_\_

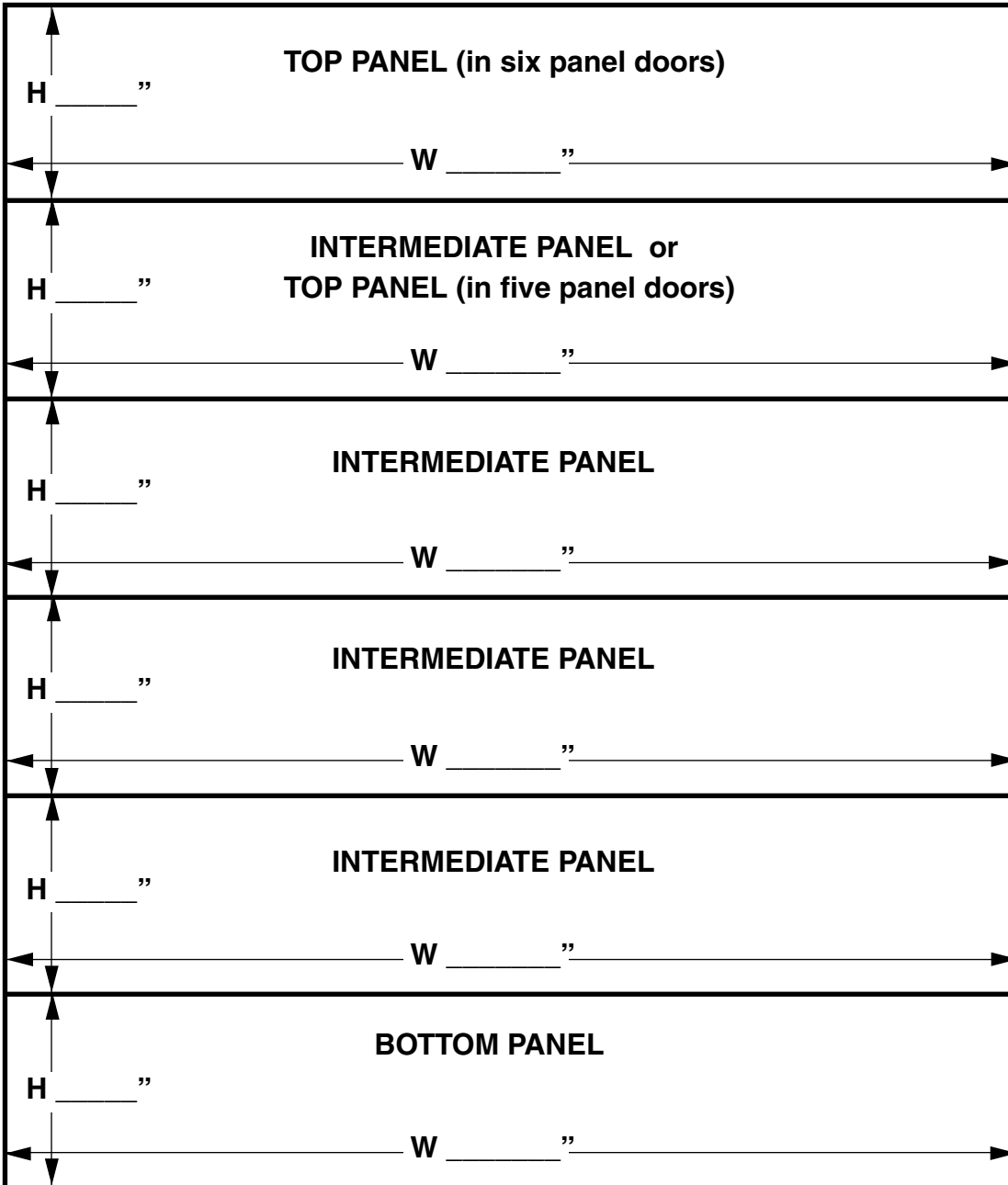

**What is ToughShell™ and Topcoat™?**

ToughShell is Todco's patented door panel coating that forms a protective shell over the front, back, tongue edge, and groove edge that resists damage caused by moisture, abrasion, chemicals, temperature extremes and UV exposure. ToughShell is a primer coating that can be finished with the paint of your choice.

Topcoat is Todco's ToughShell taken one step further. After the ToughShell primer coat is applied, a color coat, Topcoat, is added using the same method that the ToughShell primer was applied with. The Topcoat layer can be tinted to your specifications and Todco backs Topcoat with a three year warranty.

Call us if you have any questions about ToughShell or Topcoat.

*Roll-Up  
 Doors  
 Take  
 Approx.  
 3-4  
 Weeks  
 for  
 Delivery*

**ROLL-UP DOOR**

**When measuring bottom panel only include the door panel, do not include the bottom seal.**

All manufacturers' names, numbers, and descriptions are used for reference purposes only. It is not implied that any part listed is the product of the original manufacturers or approved by any of these manufacturers.

Please "X" the appropriate box for your Roll-Up Door Hardware Needs.  
Mail or Fax this page with the previous page and 131-132 when ordering a complete door.

### Truck Information:

Body Manufacturer: \_\_\_\_\_  
Year: \_\_\_\_\_  
Body Interior Wall to Wall \_\_\_\_\_  
Body Interior Floor to Ceiling \_\_\_\_\_  
Door Opening Size: Height \_\_\_\_\_ x Width \_\_\_\_\_

### Door Make:

- Todco
- Whiting
- Other \_\_\_\_\_

### Serial# (if available)

\_\_\_\_\_

### Tracks and Operator

- With Track
- Without Track
- With Operator (counterbalance)
- Without Operator (counterbalance)

### Type of panels: (See panel dimension form)

- 3/4" plywood ToughShell (Todco only w/U.V. Polymer Coating)
- 3/4" plywood, Topcoat (Todco only - 3 year warranty on finish, specify color)
- 3/4" plywood, Aluminum Covered
- Other \_\_\_\_\_  
(ie: thickness insulated, material)

### Door Paint:

- No** — Primer Only
- Yes** — Please specify paint manufacturer and code or color preference for a non-exact match. \_\_\_\_\_

**Door Seals:** All doors include top and bottom seals. Would you like side seals also?

- Include Hardware
- Exclude Hardware

**Type of Lock:** All doors come with a locking mechanism unless you specify otherwise. Please "X" Latch Type and Cylinder Type. For descriptions of each style latching mechanism look through our Todco or Whiting section of this catalog.

- Maximum Security Latch
- Maximum Security Latch w/Inside Release
- Maximum Security 'J' Latch with Lock Box\*
- Maximum Security 'J' Latch with Lock Box\* & Inside Release
  
- Two Point Latch (with center mechanism and cable controlled end latches)\*
- Slam Latch w/Locking Handle\*
- Slam Latch for keyed or padlock handle
- Exclude Locking Mechanism

- \* Choose Best or  
Standard Cylinder       Best Cylinder  
    Standard Cylinder

**Hardware:** All doors include hardware (rollers, hinges and bolts) unless you specify otherwise.

- Include Side Seals
- Exclude Side Seals

### Roller Diameter:

### Fasteners:

- 1" Diameter                       Zinc (standard)
- 2" Diameter                       Stainless Steel

### Shipping:

- Ship Standard — Your door will be shipped in two sections of three to four panels each. More than one person will be required for installation.
- Ship Panel Form — Panels are not attached to each other. Ideal for one person installation.

ROLL-UP DOOR

**MILL SUPPLY, INC.** PO BOX 28400, CLEVELAND, OH 44128-0400  
 Local (216) 518-5072 • (800) 888-5072 • FAX (888) 781-2700

**Date:** \_\_\_\_\_

**Sold To:**

Contact Name \_\_\_\_\_  
 Company Name \_\_\_\_\_  
 P.O. Box \_\_\_\_\_  
 Street Address \_\_\_\_\_  
 City \_\_\_\_\_ State \_\_\_\_\_ Zip \_\_\_\_\_  
 Phone \_\_\_\_\_

**Ship To:**

Contact Name \_\_\_\_\_  
 Company Name \_\_\_\_\_  
 P.O. Box \_\_\_\_\_  
 Street Address \_\_\_\_\_  
 City \_\_\_\_\_ State \_\_\_\_\_ Zip \_\_\_\_\_  
 Phone \_\_\_\_\_

**Fill in the Dimension Below when Ordering New Track**  
**QUICKLY REPAIR DAMAGED DOOR TRACK - see page 117**

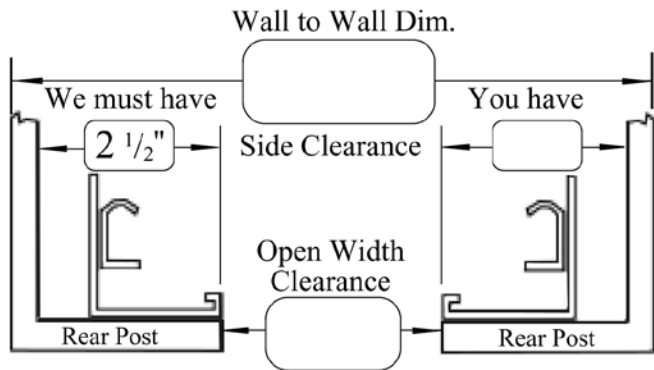

If you do not have the minimum side room clearance, you must add material and then give the above dimensions.

Make \_\_\_\_\_  
 Model \_\_\_\_\_ Year \_\_\_\_\_  
 Other Information \_\_\_\_\_

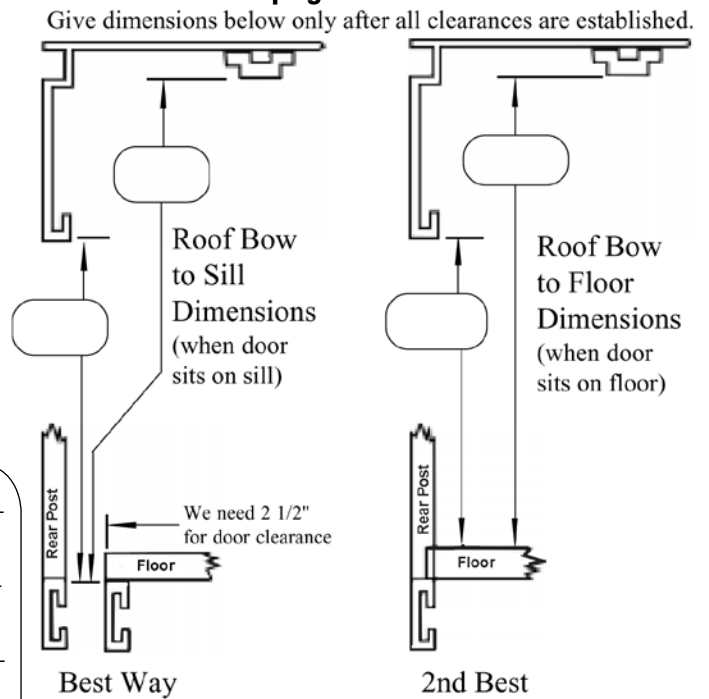

**ROLL-UP DOOR**

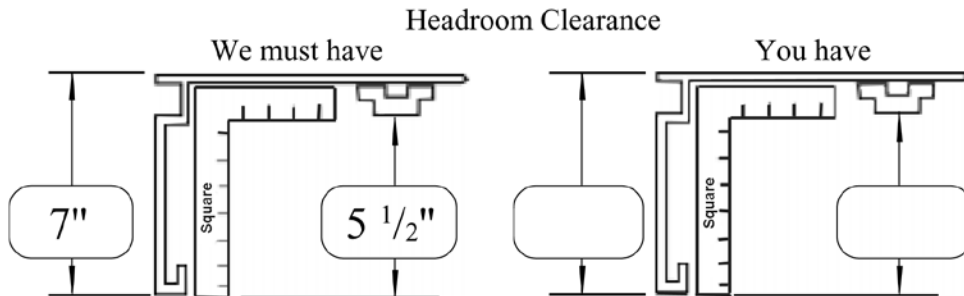

If you do not have the minimum header clearance, you must build down the header and then give us the above dimensions.

**Note:** Doors are made for net opening width, not wall to wall dimension.

**MILL SUPPLY, INC.** PO BOX 28400, CLEVELAND, OH 44128-0400  
Local (216) 518-5072 • (800) 888-5072 • FAX (888) 781-2700

This page must be signed when ordering a complete door.

I understand that this door will be made to the dimensions that I have specified. And, I will accept and pay for the door as long as the dimensions match what I requested.

Signature: \_\_\_\_\_

Print Name: \_\_\_\_\_

Date: \_\_\_\_\_

Company Name: \_\_\_\_\_

**ROLL-UP DOOR**

**TIP**

On your vehicle data records, record the roll-up door serial number (located inside in the upper right hand corner if you are facing out) on all your vehicles, especially new doors. With the serial number readily available a replacement door can be ordered quickly, efficiently and without mistakes.