

WEST COAST MIRROR ASSEMBLIES that fit GM

50-99-350-L - Left Mirror Assy.
50-99-350-R - Right Mirror Assy.

Stainless Steel Mirror assembly with 7" x 16" Stainless Steel Mirror Head. Fits C/K Series Chevrolet/GMC Pickup 1999-Current.



50-88-350-L - Left Mirror Assy
50-88-350-R - Right Mirror Assy

Polished Stainless Steel Mirror Assembly with 7" x 16" Stainless Steel Mirror Head that fit C-30 & C-65 Series Chevrolet/GMC Pickup 1988 - Current.

50-88-353-L - Left Mirror Assy
50-88-353-R - Right Mirror Assy

Painted (Black) Mirror Assembly with (Black) 7" x 16" Mirror Head that fit C-30 & C-65 Series Topkick Chevrolet/GMC Pickup All 1988 - Current.



50-88-357-L
Left Mirror Assy
50-88-357-R
Right Mirror Assy

Stainless Steel Mirror Assembly with 7" x 16" Stainless Steel Mirror Head that fits C/K Series Chevrolet/GMC, 1988-98.

WEST COAST MIRROR ASSEMBLIES that fit FORD



90-80-350



90-99-350

90-80-350-L - Left S.S. Mirror Assy with 7" x 16" S.S. Mirror Head. Fits 80-98 F-150, F250, F350 Pick-up

90-80-350-R - Right S.S. Mirror Assy with 7" x 16" S.S. Mirror Head. Fits 80-98 F-150, F250, F350 Pick-up

90-99-350-L - LH Mirror Assembly. Fits 99-on F250, F350 & F650

90-99-350-R - RH Mirror Assembly. Fits 99-on F250, F350 & F650

WEST COAST MIRRORS that fit INTERNATIONAL/NAVISTAR



33-79-351
Mirror Arm Loop Assembly.
Fits LH or RH (Less Mirror)



60-330
60-331

ENLARGED VIEW OF BULLET PLUG

Heated Mirror Heads



60-310

Other Heated Mirror Heads shown on page 181.

33-79-351 Aluminum Mirror Arm Loop Assembly without Mirror Heads. Can be used on LH or RH. Fits S Series International/Navistar 1979-Mid 2002

60-310 7" x 16" Flange Mount Mirror, Aluminum Non Heated

60-330 7" x 16" Heated Mirror Head with International Bullet Plug, Driver Side

60-331 7" x 16" Heated Mirror Head with International Bullet Plug, Passenger Side

180 REPLACEMENT
WEST COAST MIRRORS



W-180
7" x 16" Steel Head
(White) with 5/16" stud



60-310
7" x 16" Flange Mount Mirror, Aluminum. Fits International 'S' Series



ML-10-132
7" x 16" Aluminum (White) with 5/16" stud



1152
6" x 16" Aluminum with 5/16" stud



1162
7" x 16" Stainless Steel, that fits GMC Kodiak w/5/16" stud



S-158-K - 6" x 16" Aluminum Flange Mount with Yellow Chevrons
S-158-K1 Glass Only



S-158-KDV - 6" x 16" Aluminum Double Vision with Convex Spot Mirror on Bottom. With Yellow Chevrons

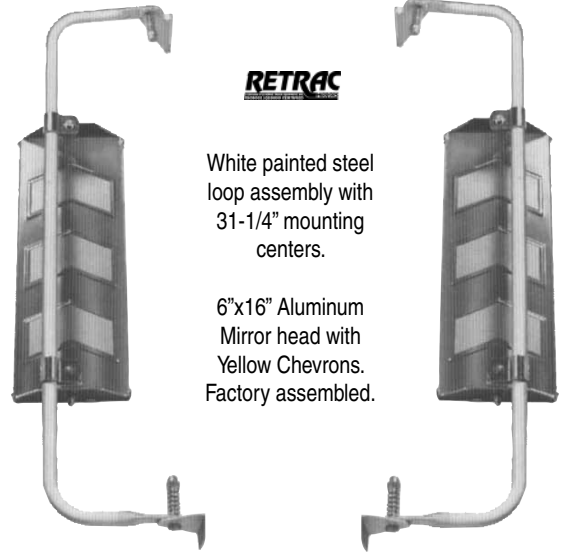

159SA - Mirror Assembly Pair of LH & RH

White painted steel loop assembly with 31-1/4" mounting centers.

6"x16" Aluminum Mirror head with Yellow Chevrons. Factory assembled.



600807 - 7" x 16" Stainless Steel Mirror Head
600682 - 7" x 16" White
600685 - 7" x 16" Black



180
6" x 12" Aluminum Mirror Head with Yellow Chevrons

MIRROR

HEATED WEST COAST MIRROR HEADS



1162H - 7"x16" Heated Polished Stainless Steel, w/wire harness, w/o plug.



M-616 - 7"x16" Heated Polished Stainless Steel, w/wire harness, w/o plug.



1157-H - 7"x16" Heated Polished Stainless Steel, w/wire harness, w/o plug.
60-345 - Same as 1157H but with harness & plug, fits Navistar



1162-IHO - 7"x16" Heated Polished Stainless Steel, w/wire harness, w/flat plug, fits Navistar.



ENLARGED VIEW OF BULLET PLUG

60-330 Driver Side
60-331 Pass. Side
7" x 16" Heated with Bullet Plug that fits Navistar & International

STUD MOUNT SPOT MIRRORS



61-455 - 5" Dia. with Stud & Clamp on Mtg., **center mount stud**, fits all tubular brackets, Black.



61-477
7-1/2" Dia. Aluminum Spot Mirror with **offset stud**



723080
Stainless steel "L" Bracket for Spot Mirrors

61-457 - Same but Stainless Steel



61-475 - 7-1/2" Dia. Spot Mirror. stainless steel with "L" bracket, with 1/4" **offset stud**



61-487 - 5-1/2" x 7-1/2" Rectangular Spot Mirror with 1/4" Ball Stud, Bright Aluminum.



708556 - 8-1/2" Dia. Spot Mirror with "L" bracket, **center mount stud**



NEW
708560 - 8-1/2" Dia. Heated Spot Mirror, stainless steel, with "L" bracket, **offset stud**



NEW
712245 - Wide Angle Conversion kit. Includes 6" x 6.5" stud mount mirror head and 3/4" O.D. arm

STICK-ON SPOT MIRRORS



61-485 - "The Wedge" Corner Mount Spot Mirror 3-3/8" Overall size



61-482 - 2" dia.

61-483 - 3" dia.

61-484 - 3-3/4" dia.



61-486
4" x 5-1/2"

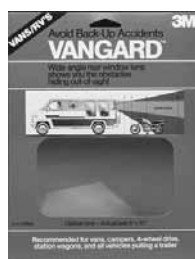

Wide-angle window lenses show obstacles hiding out of sight. Easily applied and removed by hand using water only.

3M-7950 8" x 10" Vanguard™ Wide-Angle Window Lens.

3M-7951 11" x 14" Super Vanguard™ Wide-Angle Window Lens.

Velvac Mirror Heads and Glass

6.5" x 10" FLAT GLASS HEADS

VELVAC



704091	stainless steel head w/glass
704032	white steel head w/glass
704081	gray plastic head w/glass
704132	white plastic head w/glass
704152	black plastic head w/glass
703102	gray gasket for plastic heads
702076	glass only

6.5" X 6" FLAT GLASS HEADS

VELVAC



704093	stainless steel head w/glass
704078	white steel head w/glass
704178	white plastic head w/glass
704159	black plastic head w/glass
703101	gray gasket for plastic heads
702051	glass only, flat

6.5" X 6" CONVEX GLASS HEADS

VELVAC



704095	stainless steel head w/glass
704077	white steel head w/glass
704177	white plastic head w/glass
704153	black plastic head w/glass
703101	gray gasket for plastic heads
702023	new style glass for steel heads
702057	standard glass only, convex

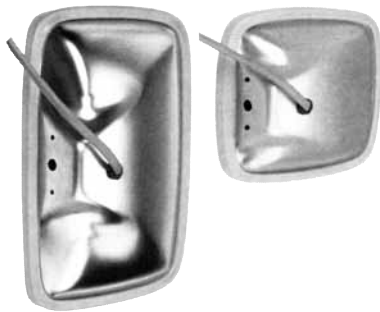

Heated Mirror Heads

VELVAC

Part No.	Description
704315	6.5" x 6" Heated S.S. Mirror Head with Convex Glass & Wire Harness
704325	6.5" x 10" Heated S.S. Mirror Head with Flat Glass & Wire Harness

Preset Hardware Kit for Existing Preset Loops

- Can be used on all Velvac preset style loop ends.
- 5/16" - 18 thread stainless steel hardware with 1-1/2" long pivot bolt.
- Kit contains parts for one complete Velvac preset pivot assembly.



748010

MIRROR HEAD MOUNTING CLAMPS for 3/4" tubing



SS-1245
Mirror Clamp Kit



SS-1247
Offset Clamp



SS-1251
Twist Clamp

Preset Repair Kits for Existing Preset and Non Preset Loops

Repair worn detants on newer trucks or install preset feature on loops that never had it. If the rivets (detants) are worn out on your loops, use this kit. The stamped stainless steel plate has the detants pressed in. It fits over the rivets that were on the loop originally. The kit also comes with a spring to replace the rubber bushing. No more guesswork for adjusting the tension on the assembly. If you have any truck mirrors without the preset feature, use this kit to give any loop presets without replacing the loop.

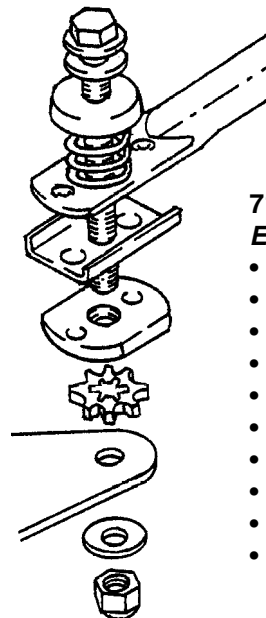

VELVAC

- 712979 Preset Kit
Each kit contains:
- Hex Head Pivot Bolt
 - Two Flat Washers
 - Retaining Cap
 - Nylon Washer
 - Tension Spring
 - Rivet Plate
 - Lock Plate
 - Int/Ext Lock Washer
 - Elastic Locknut
 - Instructions

MIRROR

Custom Wide Angle Mirror Systems for Walk-in Vans

Custom mirror systems all include 6.5" x 10" upper flat glass and 6.5" x 6" lower convex glass mirror heads. Replacement mirror heads and glass are listed on the previous page. All assemblies come with cabfeet.

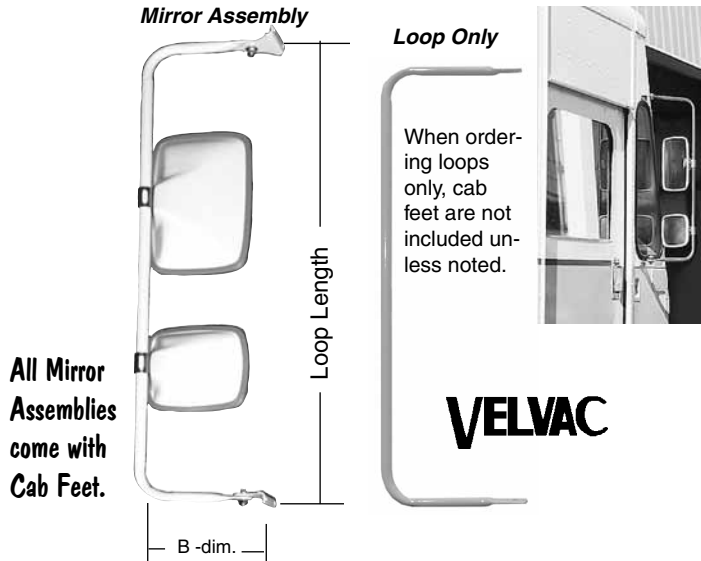

All Mirror Assemblies come with Cab Feet.

Loop Only

When ordering loops only, cab feet are not included unless noted.

VELVAC

11-1/4" LOOP WITH PRESETS — with 7" 'B' Dimension
W-780484 - White Loop for 704032-5 Mirror (less cab feet) (each)

30" LOOPS WITH PRESETS — with 9" 'B' Dimension

- 712369** - LH Stainless Steel Assembly
- 712370** - RH Stainless Steel Assembly
- T-780680-9** - Stainless Steel Loop Only (less cabfeet) (each)
- W-780680-9** - White Loop Only (less cabfeet) (each)

30" LOOPS WITHOUT PRESETS — with 9" 'B' Dimension

- 724007** - Stainless Steel Mirror Assembly (pair)
- 60-516** - Stainless Steel Loop with Cabfeet (each)
- 30" LOOPS WITHOUT PRESETS — with 6-1/2" 'B' Dimension**
- 712633** - LH White Mirror Assembly (each)
- 712634** - RH White Mirror Assembly (each)
- 712631** - LH Stainless Steel Mirror Assembly. (each)
- 712632** - RH Stainless Steel Mirror Assembly. (each)
- T-7808250** - Stainless Steel Loop Only (less cabfeet)

33" LOOPS WITHOUT PRESETS — with 6-1/2" 'B' Dimension

- 727067** - White Mirror Assembly (pair)
- 724008** - Stainless Steel Assembly (pair)

35-1/2" LOOPS WITH PRESETS — with 10" 'B' Dimension

- 713743** - LH Stainless Steel Assembly
- 713742** - RH Stainless Steel Assembly
- 713784** - S.S. Loops only with Cabfeet (pair)

Cabfeet with Hardware without Presets

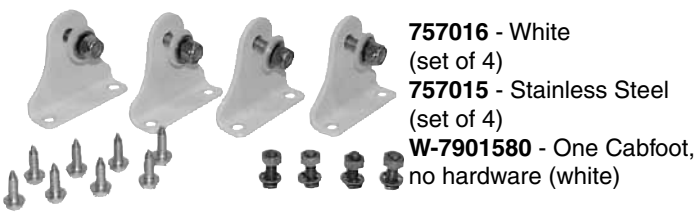

- 757016** - White (set of 4)
- 757015** - Stainless Steel (set of 4)
- W-7901580** - One Cabfoot, no hardware (white)

VELVAC

Used On Utilimaster

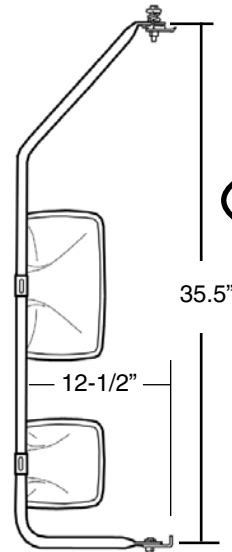

All Mirror Assemblies come with Cab Feet.

- W7812330** - Loop Only, Span 35.5", White (less cab feet)
- Q7812330** - Loop Only, Span 35.5", Flat Black (less cab feet)
- W7901580** - Cabfoot, White
- Q7901580** - Cabfoot, Flat Black

- 714958** - Mirror Assembly w/Preset, White, Pair
- 714959** - Left Side Mirror Assembly w/Preset, White
- 714960** - Right Side Mirror Assembly w/Preset, White

- 714961** - Mirror Assembly w/Preset, Flat Black, Pair
- 714963** - Left Side Mirror Assembly w/Preset, Flat Black
- 714962** - Right Side Mirror Assembly w/Preset, Flat Black

- 714964** - Mirror Assembly w/Preset, Stainless Steel, Pair
- 714965** - Left Side Mirror Assembly w/Preset, Stainless Steel
- 714966** - Right Side Mirror Assembly w/Preset, Stainless Steel

MOUNTING HARDWARE

RIVET-NUT

Designed for high speed installation of mirror assemblies. Builds nut right into the body of the vehicle. Mounts in seconds with professional results. Leave the nut on the body for easy removal and reassembly.



M-47274 - 5/16"-18 Aluminum Rivet-Nut
Grip Range: .126"-.200"
Quantity: 25/box



M-47254 - 1/4"-20 Aluminum Rivet-Nut
Grip Range: .141"-.200"
Quantity: 40/box



M-39200
Rivet-nut Mounting Tool

M-39258
1/4"-20 Mandrel
M-39259
5/16"-18 Mandrel



AV-13232 - 1/4" Fasteners for mounting mirrors, 25 per box



AV-14156 -P- Friction wrench for AV-13232

MIRROR

Mirror Systems that fit GMC TopKick, Savana & Chevrolet G3500/Express 1996 and Newer



VELVAC

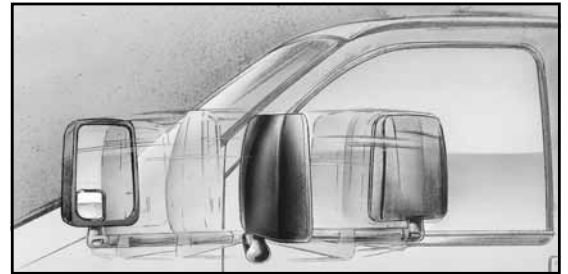

Foldaway mirrors return to preset driving position without readjustment or need for tools.

Velvac's 2020 door mounted mirror systems fit the GMC TopKick truck providing an attractive and cost-effective alternative to the OE cowl mounted mirror.

- Deluxe head provides greater visibility around the vehicle when compared to OE mirror deluxe head is recommended for TopKick applications.
- Easily replaceable head and glass make for less expensive mirror system servicing.
- New black powder coated cover plate attaches quickly over OE mirror mounting area and provides a clean, finished appearance—one kit required per vehicle. Kit includes LH and RH.



STANDARD

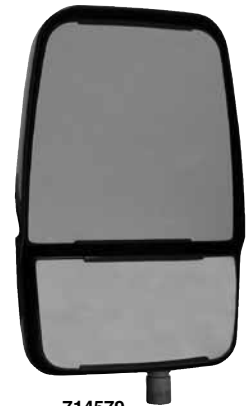

DELUXE

Standard mirror heads feature 57 (sq. in.) of flat glass plus a unique wedge-shaped corner convex for blind spot visibility.

Deluxe Mirror Head includes independently adjustable flat (62 sq. in.) and convex glass (30 sq. in.)

Complete Replacement Manual Mirror Assemblies by Velvac that fit 1996-on GMC TopKick, Savana & Chevrolet G3500/Express

Body Width	Color	Type	Pair	RH Side	LH Side
102"	Black	Deluxe	714548	714550	714549
102"	Black	Standard	714560	714562	714561
96"	Black	Deluxe	714545	714546	714547
96"	Black	Standard	714557	714558	714559

Cover Plate set (one pair). Attaches quickly over OE mirror mounting area. Black powder coat finish. **709785**

Replacement Glass	Part No.
Heated Flat Glass on Deluxe models. Fits LH or RH	709448
Heated Convex Glass on Deluxe models. Fits LH or RH	709589
Flat Glass & Wedge Mirror for Standard models. Fits L or R	709407

Replacement Mirror Heads		
Color	Mirror Head	Part No.
Black	Deluxe, Manual, LH	714579
Black	Deluxe, Manual, RH	714580
Black	Deluxe, Heated/Remote, LH	714581
Black	Deluxe, Heated/Remote, RH	714582
Black	Standard - Universal	714575
Black	Standard, Heated/Remote	714577

Mill Supply has Catalogs for Variety of other Products we carry - You can order these catalogs over the phone (800-228-6436 ext. 2) or On-line: www.MillSupply.com

Car Restoration or Truck Restoration

Each catalog carries at least 3000 restoration panels for foreign and domestic cars, trucks and vans

- Fenders
- Rocker Panels
- Wheel Arches
- Door Panels

Plus other items like gas tanks, trunk floors, and dash tops.

Discount Snow Plow Parts

This catalog lists replacement parts that fits Meyer, Western, Sno-Way, Diamond, Fisher, and Boss and...

- Easy on-off plow carts
- Salt Spreaders
- Utility Lights
- Plow Blades

Automotive Fasteners

Automotive Hardware & Fasteners with 1500 items you sure to find what you need. This catalog includes:

- Clips & Fasteners
- Rivets
- Weatherstrip
- Screws & Bolts

A variety selection of kits in stock.

Commercial Mowers and Landscaping Products

This catalog only available as a PDF (Download)

Replacement parts for Bobcat, John Deere, Scag and many more

- Blades
- Filters
- Spindles
- Wheels

Go to www.millsupply.com to download the catalog.

VELVAC Mirror Systems that fit E-350 Ford Econoline



1992 and Newer

Standard mirror heads feature (57 sq. in.) of flat glass plus a unique wedge-shaped corner convex for blind spot visibility.

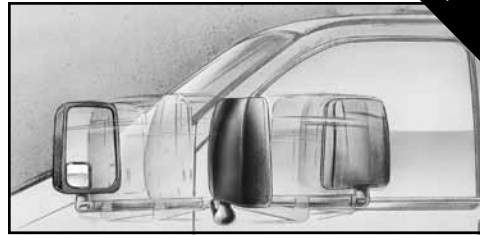

Foldaway mirrors return to preset driving position without readjustment or need for tools.



Standard Mirror Head



Deluxe Mirror Head

Deluxe Mirror Head includes independently adjustable flat (62 sq. in.) and convex glass (30 sq. in.)



These mirror assemblies feature the original appearance and unique pivot design which allows the mirror head and arm to rotate safely 80° forward or rearward if impacted or, to prevent damage when maneuvering through tight spaces. The pivot also provides for an easy-to-locate preset driving position. This new mirror replaces the original equipment mirrors and installs in existing mounting pockets using factory mounting holes.

1992-2002 Complete Replacement Manual Assemblies

Body Width	Color	Mirror Assy.	Pair	Right Side	Left Side
102"	Black	Deluxe	714470	714472	714471
102"	Black	Standard	714485	714486	714487
96"	Black	Deluxe	714467	714468	714469
96"	Black	Standard	714482	714484	714483

2003 & Newer Complete Replacement Manual Assemblies

Body Width	Color	Mirror Assy.	Pair	Right Side	Left Side
102"	Black	Deluxe	715452	715454	715453
102"	Black	Standard	715407	715408	715409
96"	Black	Deluxe	715449	715450	715451
96"	Black	Standard	715404	715406	715405

Replacement Manual & Heated Mirror Heads and Glass

Color	Mirror Heads and Glass	Manual	Heated/Remote
Black	Deluxe Head - Left Side	714579	714581
Black	Deluxe Head - Right Side	714580	714582
Black	Standard Head - Universal	714575	714577
	Flat Glass for Deluxe head, Fits LH or RH		709448
	Convex Glass for Deluxe head, Fits LH or RH		709589
	Flat Glass & Wedge mirror for Standard head. Fits LH or RH	709407	709748
	"The Wedge" Corner-Mount stick-on convex spot mirror	61-485	

Replacement Parts for original style mirror head.

OLD STYLE



Complete assembly no longer available



- Replacement mirror head for old style Econoline van mirrors (includes Wedge convex)
- Fits on both left side or right side
- Available in black or white
- See mirrors on left for new complete assemblies.

- 714256 - Black Std Manual Head
- 714258 - White Std Manual Head
- 709407 - Flat Glass with Bezel & Wedge Convex.
- 61-485 - "The Wedge" Stick-on Corner Mount Convex Spot Mirror

Mirror Systems that fit 1998 & Newer VELVAC Ford Super Duty F-250-F-750

Complete Replacement Manual Mirror Assemblies by Velvac

Body Width	Color	Type	Pair	RH Side	LH Side
102"	Black	Deluxe	714518	714520	714519
102"	Black	Standard	714530	714532	714531
96"	Black	Deluxe	714515	714516	714517
96"	Black	Standard	714527	714528	714529

Upper Flat Glass on Deluxe models Fits LH or RH	709448
Lower Convex Glass on Deluxe models. Fits LH or RH	709589
Flat Glass & Wedge mirror for Standard models. Fits LH or RH	709407



STANDARD

Standard mirror heads feature 57 (sq. in.) of flat glass plus a unique wedge-shaped corner convex for blind spot visibility.

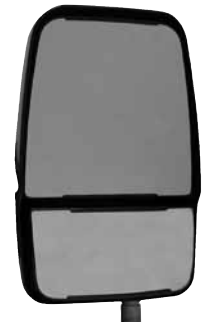

DELUXE

Deluxe Mirror Head includes independently adjustable flat (62 sq. in.) and convex glass (30 sq. in.)

MIRROR

MIRRORS that fit FORD PICKUPS

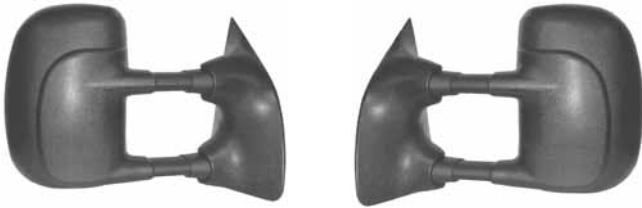

- 90-99-367** LH Extendable Mirror Assembly that fits 99-ON F250/F350/S-D and 2000-ON Excursion
- 90-99-368** RH Extendable Mirror Assembly that fits 99-ON F-250/350/S-D and 2000-ON Excursion



- 90-03-369** LH Telescopic Mirror Assembly that fits 2003-on E Series Vans
- 90-03-370** RH Telescopic Mirror Assembly that fits 2003-on E Series Vans

SUPER-VU

Wide Angle Convex Mirror • Sold in Pairs

Fits E-Series Mirrors (90-03-369 & 90-03-370 shown above) and F-250-F550 Series Tow Mirrors.

Triple Wide angle viewing

- No vibration
- Less eye strain
- Integral styling
- Installs in minutes



From this... ▲

...To this! ▲

61480 - Super View Convex Mirror Extension. One Pair of LH and RH

UNIVERSAL BELOW EYE LEVEL MIRROR ASSEMBLIES & HEADS



2809-35

2809-15 - Below eye level assy with external mount head, **white**, one side

2809-35 - Below eye level assy with external mount head, **stainless steel**, one side per box

1211-35 - Head only, **stainless steel**

1211-35



60615 - 7.5"x 10.5" Head only **with 2" extra long elbow, stainless steel**

60615

MIRRORS that fit SPRINTER VANS

Replacement mirror assemblies make it easy to add the safety of Velvac's wide angle mirror system to any Sprinter van.



NEW
VELVAC

NEW
715704 - Side Mirror Assembly (PAIR). Includes: mirror heads and loop. (Base not included) (Assemblies mount to existing OE base) Does not fit 2007 and newer Sprinter vans.

NEW
704152 - Replacement 6-1/2" x 10" flat glass mirror head, black plastic
704153 - Replacement 6-1/2" x 6" convex mirror head, black plastic

Mirror assy does not include mount base.

- 6-1/2" x 10" upper flat glass head and 6-1/2" x 6" lower convex provide a great view of passing lanes and blind spot areas around the sides of the vehicle
- Designed to mount directly to the OE mirror mounting base in minutes
- Cast aluminum mounting ends attach to existing pivot system allowing mirrors to fold forward and back for added safety and convenience
- Black powder coated brackets and molded mirror heads match existing mounting bracket and vehicle trim

REAR CROSS VIEW MIRROR SYSTEM that fits SPRINTER VAN

When used in combination with Velvac's wide angle mirror system (shown on page 186) this new back-up mirror system provides the Sprinter driver with the view directly behind the vehicle for added blind spot coverage. Features a 10" molded convex mirror for optimum visibility and adjustment.



715719 - Back-Up Safety Mirror System with 10" diameter mirror head that fits Sprinter Vans. Stainless steel tube bracket with aluminum mounting plates and stainless steel hardware.

708543 - 10" Diameter mirror head only

VELVAC

MIRROR

VAN & CAB CHASSIS MIRROR SYSTEMS

Door/Fender Mount Mirror Kits

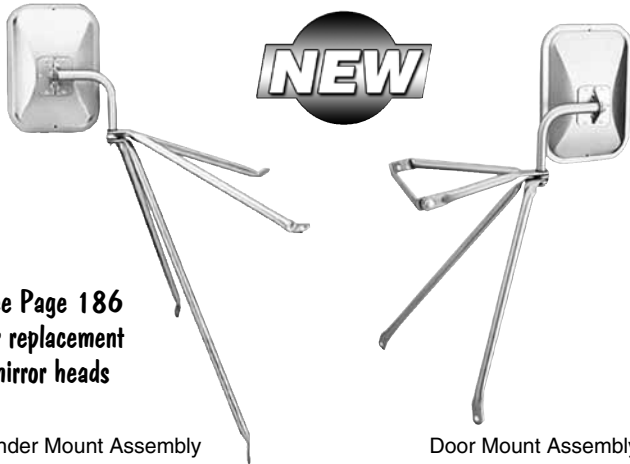

See Page 186
for replacement
mirror heads

Fender Mount Assembly

Door Mount Assembly

- Ideal for use on people mover vehicles
- 7.5" x 10.5" Flat glass mirror heads
- Kits included stainless steel right side fender mount and left side door mount mirror assembly (mirror heads and 3/4" O.D. brackets).
- Mounting hardware not included

NEW

713883 - LH & RH Door/Fender Mount Mirror Kit that fits 1997 and Newer Chevrolets

713156 - RH Mirror Kit for 713883

713155 - LH Mirror Kit for 713883

NEW

713154 - LH & RH Door/Fender Mount Mirror Kit that fits 1992 and Newer Ford Econolines

See page 185 for other Econoline Mirrors

Universal Low Mount Mirror Kit

NEW

See Page 186
for replacement
mirror heads



NEW

712479

- Stainless Steel
- Sold in pairs
- Mounting hardware not included
- For use on vehicles with up to 96" wide bodies
- 7.5" x 10.5" Flat glass mirror head
- Solid elbow & one piece lower tubing brace for mounting stability

33910002

Replacement Stainless Steel 90 degree elbow

Stylized Door/Fender Mirror Kits

Kits designed to fit 2003 and newer Ford Econoline van chassis where right side fender mirror mounting is required. Typical applications include people mover vehicles and airport buses.

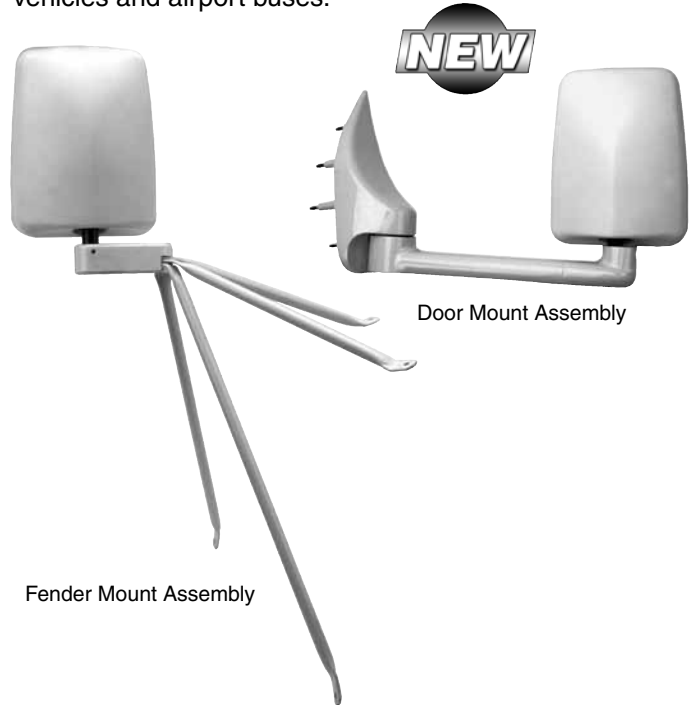

Fender Mount Assembly

Door Mount Assembly

Kits Include:

- White mirror heads featuring 57 square inches of flat glass (714576 & 714578 listed below) plus corner mount wedge-shaped convex spot mirror (Listed below)
- LH side door mounting bracket
- RH side fender mounting brackets
- White Powder coated aluminum and tubular components

NEW

715720 - Door/Fender Stylized Mirror Kit with Manually Adjustable glass

NEW

715721 - Door/Fender Stylized Mirror Kit with Heated Remote glass

NEW

714576 - Manual White Mirror Head

714578 - Heated/Remote White Mirror Head

61-485 - Corner Mount Spot Mirror



714576



61-485

MIRROR

REAR VIEW SYSTEMS FOR STEP VANS

FIXED POSITION REAR CROSSVIEW SYSTEMS

A universal mounting bracket lets this mirror mount to any flat surface. Kit includes: 10" wide view mirror head, reinforced 3/4" O.D. tubing arm, heavy duty mounting bracket, and stainless steel hardware.

VELVAC

10" WHITE ASSEMBLY

- Complete Assembly..... **712644**
- White Mirror Head Only.....**709217A**
- White Bracket Kit Only..... **712642**
- Gasket Only..... **709214**

10" STAINLESS STEEL ASSEMBLY

- Complete Assembly..... **712643**
- Stainless Steel Mirror Head Only .. **709218**
- S.S. Bracket Kit Only **712641**
- Gasket Only..... **709214**



REBOUND™ TECHNOLOGY REAR CROSSVIEW SYSTEM



Rosco's patented "Rebound™ Technology" allows the wrap around mirror arm, not the mirror head, to be hit. "Rebound™ Technology" springs the arm back in its original place when the vehicle moves away from the obstruction.

Although the mirror head comes standard with an acrylic unbreakable 11" convex lens, Rebound™ auto-return technology allows the mirror head to always remain properly adjusted for safe and effective rear cross viewing. Stainless steel mirror, arm, mount and hardware.

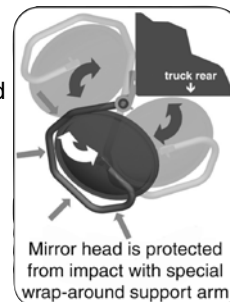

- Side Mount Rebound™ System **61-020**
- Rear Mount Rebound™ System **61-022**

SPRING LOADED DETENT REAR CROSSVIEW SYSTEMS

(Easily move mirror out of the way for vehicle storage or washing then return to the preset viewing position.)

VELVAC

View of units with
and without exten-
sion handle.

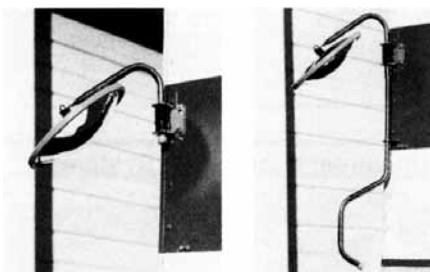

System without
Extension Handle

System with Ex-
tension Handle

Easy to Position — An innovative, spring-loaded detent system allows the mirror to be folded away for vehicle storage or washing then returned to preset viewing position. An optional extension handle completes the system and allows for easy mirror positioning without having to reach or climb onto the vehicle.

- Shatter resistant, 10" diameter wide view mirror head with 8-1/2" radius.
- Available in powder-coated galvanized steel finish.
- All systems include convex mirror head, fully assembled and pre-positioned arm and mounting hardware.

- Spring Loaded Detent System **714407**
- without Extension Handle
- White Extension Handle Only..... **714410**

BREAK-AWAY REAR CROSSVIEW SYSTEM

Allows mirror to pivot when struck by an object.



- Break-Away System with mirror head..... **61-005**
- Mounting Bracket only with mounting hardware..... **MB-647**
- 10" Mirror Head Only, Stainless Steel..... **709218**

These safety systems provide the driver with the ability to view the dangerous blind spot area around the rear bumper of the vehicle. Being able to view this area before backing-up can help reduce accidents.

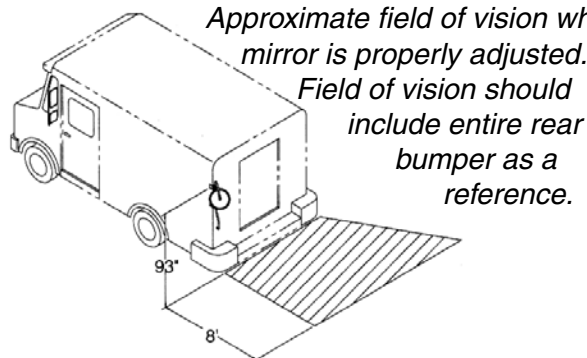

Approximate field of vision when
mirror is properly adjusted.
Field of vision should
include entire rear
bumper as a
reference.

MIRROR

REAR CAMERA VIDEO SYSTEM

Clearly view the area behind your vehicle.



14-350 \$355.00 7-Inch LCD Color Video Display Camera System

Camera Features:

High-Resolution Color Camera with 1/3-inch Sony Image Sensor (Wide-Angle Auto-iris Lens that automatically adjusts to light conditions. Approx. 15' of viewing at night with backup/reverse light on). Compact, Lightweight, Waterproof, Aluminum Die-Cast Housing with Integrated Microphone. Built-in Normal/Mirror Image Switch. Adjustable Stainless Steel Mounting Bracket. 10-15 volt. Dim: 2-3/4" x 1-3/4" x 2-1/4".

Monitor Features:

Crystal clear 7" LCD Monitor (Up to 4 Camera Inputs) Includes Mounting Bracket, Remote Control, Extension Cable and Sunvisor Shroud. Includes frontal AV input, headphone jack and built-in speaker option.

Monitor Specifications:

LCD Monitor 7-3/4"x5"x.9" with a 1440 x 234 pixel resolution. 2 Video input/on screen display. Optional "Auto power" (allows auto function when vehicle is put in reverse gear).

SYSTEMS FOR SPRINTER VAN

When used in combination with Velvac's wide angle mirror system (shown on page 186) this new back-up mirror system provides the Sprinter driver with the view directly behind the vehicle for added blind spot coverage. Features a 10" molded convex mirror for optimum visibility and adjustment.

715719 - Back-Up Safety Mirror System with 10" diameter mirror head that fits Sprinter Vans. Stainless steel tube bracket with aluminum mounting plates and stainless steel hardware.

708543 - 10" Diameter mirror head only

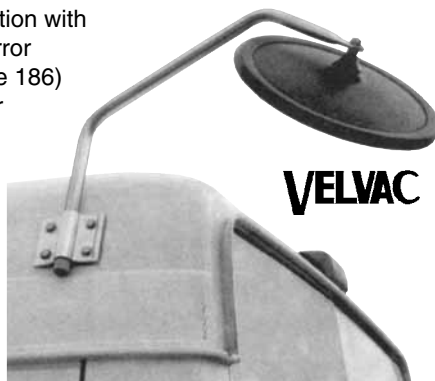

SYSTEMS FOR VANS

Kits include: 8" convex wide view mirror head, tripod bracket and stainless steel hardware and rivnut fasteners for mounting.

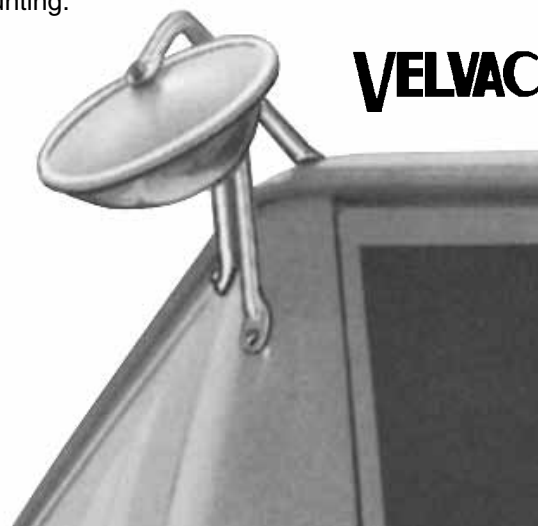

Assemblies that fit 1992 and Newer Fords

WHITE 8" ASSEMBLY

Complete Assembly.....	713120
White Mirror Head Only	708450
Black Mirror Head Only	709020
White Bracket Only	713118

STAINLESS STEEL 8" ASSEMBLY

Complete Assembly.....	713121
Stainless Steel Mirror Head Only	708448
Stainless Steel Bracket Only	713119

Assemblies that fit 1997 and Newer

Chevrolets

WHITE 8" ASSEMBLY

Complete Assembly.....	713796
White Mirror Head Only	708450
Black Mirror Head Only	709020

STAINLESS STEEL 8" ASSEMBLY

Complete Assembly.....	713798
Stainless Steel Mirror Head Only	708448

Assemblies that fit:

Chevrolet - 1971 - 96

Dodge - 1971 - 97

Ford - 1975 - 91

WHITE 8" ASSEMBLY

Complete Assembly.....	712639
White Mirror Head Only	708450
Black Mirror Head Only	709020

STAINLESS STEEL 8" ASSEMBLY

Complete Assembly.....	712640
Stainless Steel Mirror Head Only	708448

MIRROR

SAFETY CROSS™ MIRROR SYSTEM

This new 'Safety Cross™' View Mirror System uses a large convex lens that gives exceptional image definition and superior field-of-view. Mirror heads are available in standard or heated. Bases include: flat mount or curved mount.



61-493 Standard Mirror Head only. Black ABS plastic

61-494 Heated Mirror Head only. Black ABS plastic

Stainless steel arms can be used for the standard or heated mirror head. Wires run through the hollow arm. The extruded aluminum base is black powder coated. Fasteners are stainless steel.



61-491 Flat mount base with arm.



61-492 Curved mount base with arm (mounts on corner of fender, shown above)

NEW

HOOD MOUNT MIRROR



NEW
713444 - Standard Hood Mount Mirror and Bracket Assembly.
'A' Dim: 21" to 32.75"

NEW
714721 - Short Hood Mount Mirror and Bracket Assembly
'A' Dim: 17.5" to 24.5"

- 8-1/2" convex mirror heads feature the DuraBall nylon ball joint system
- All stainless steel construction
- Kits include adjustable braces, mirror head and mounting hardware
- Two bracket kits fit a variety of vehicle hood configurations:
 - Standard tripod system for use on most hoods
 - Short tripod system for use on slope nose vehicles like Freightliner Century Class trucks or on vehicles where the tops of the fender and hood are close together

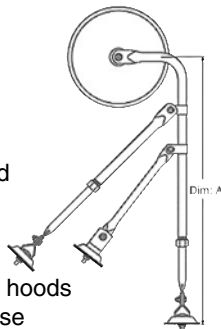

BACK-UP ALARMS

Self-Adjusting Back Alarm



EASILY MOUNTS to any Flat Horizontal or Vertical Surface



BA-1040 - Adjusts itself from 87 to 112 decibels depending on the outside noise levels. If conditions are noisy outside, the back alarm will increase in volume.

97 Decibel Back Alarm



EASILY MOUNTS to any Flat Horizontal or Vertical Surface

87-005 Rated at 97 decibels this back alarm gives a clear warning to all who are behind a vehicle. Can be mounted on any flat vertical or horizontal surface. Install with back-up light negative ground or with separate switch. Installation instructions included. Made in Canada.



2-Year Warranty

4" Round Back Alarms



Remove One Back-Up Lamp and Replace it with this 97 Decibel Back Alarm

87-026 - Solid state 4" round back alarm is resistant to elements and fits into a 4" grommet. DOT law only requires one back-up lamp. Rated at 97 decibels. Easy to wire.

94993 - Pigtail

40700 - Grommet



MIRROR

WELL NUTS



Neoprene with Captive Brass Nut

Part No	Size	Grip Range	Quantity
AV-16255	1/4"-20	.187-.343"	15
AV-16253	1/4"-20	.250-.457"	25
AV-13011	5/16"-18	.015-.187"	10
AV-13001	M6-1.0 with S.S. screw	.015-.094"	50
AV-13003	M6-1.0	.015-.094"	50
AV-16256	M8-1.25	.015-.156"	10

SMALL FLANGE THREADED INSERTS FOR THIN MATERIAL

Standard	Size	Grip Range	Quantity
M-47455	1/4"-20	.030-.165"	40
AV-11314	5/16"-18	.040-.200"	25
AV-16785	3/8"-16	.040-.200"	20
Metric	Size	Grip Range	Quantity
AV-12984	6mm	.030-.165"	40
M-47413	8mm	.030-.165"	25

LARGE FLANGE THREADED INSERT FOR THIN MATERIAL

Steel	Aluminum	Size	Grip Range	Quantity
AV-16192	M-47250	1/4"-20	.020-.080"	40
M-47152		1/4"-20	.080-.140"	40
M-47171	M-47271	5/16"-18	.030-.125"	25
	M-47274	5/16"-18	.125-.200"	25
M-47184	M-47284	3/8"-16	.115-.200"	20

THREADED INSERT TOOL

M-39200 - Threaded insert tool for thin sheet inserts. (Will set 6-32 to 3/8" in aluminum and 6/32 to 1/4"-20 in steel with large flange inserts, and all small flange inserts) Includes nosepieces and mandrels for setting 8-32, 10-24 and 10-32 inserts.



ADDITIONAL MANDRELS AND NOSEPIECES FOR M-39200

Size	Mandrel
1/4"-20	M-39258
5/16"-18	M-39259
3/8"-16	M-39260
6mm	M-39268

PROFESSIONAL THREAD INSERT SETTER KIT

M-39202 - A professional tool kit featuring M-39200 thread setter and an assortment of threaded inserts, 6-32, 10-24, 10-32, 1/4"-20, and 5/16"-18 threads. Includes required nosepieces and mandrels for setting the above sizes, plus service tool. All components fit in moulded heavy-duty plastic case.



JACK NUTS



AV-13017



AV-13231



AV-13232



AV-16235

Part No	Size	Grip Range	Quan.
AV-16235	1/4"-20 w/raintite sealer	.015-.187"	15
AV-13017	1/4"-20	.187-.375"	25
AV-13231	1/4"-20 with 7/8" screw		25
AV-13232	1/4"-20 screw and jack nut		25

FRICTION WRENCH

AV-14156-P

For use when installing a limited quantity of Jack Nuts. Insert the wrench between the screw and the head of the fastener, hold wrench and run in screw to set Jack Nut. (one per pkg)

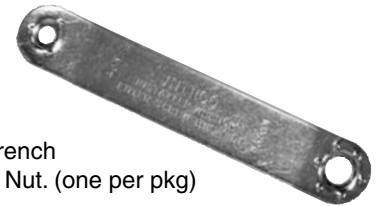

HYDRAULIC RIVETERS

M-1607 This Hydraulic Riveter provides complete fastening capabilities for aluminum and steel rivets up to 1/4". It is powered by a unique hydraulic system that is extremely easy to pull yet can develop up to 3500 lbs. of force. **ADD KIT M-1608 TO CONVERT M-1607 TOOL FOR INSERTING 10-24 and 1/4-20 THREADED INSERTS**

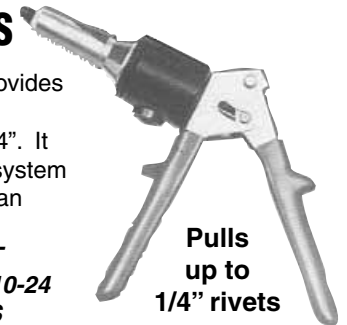

Pulls up to 1/4" rivets

16-025 - 1/4" Capacity - Air/Hydraulic Riveter.

The smallest, yet most powerful reciprocating hydraulic riveter made. Sets 1/8" through 1/4" steel rivets with up to 3500 lbs. of pull. Full 5/8" travel allows most rivet installations in one cycle. Operates between 90 and 120 psi. air pressure.

202929 - Replacement Jaws (3pc) for 16-025



MADE IN U.S.A.

THREADED INSERT TOOL FOR 5/16" INSERTS



M-1593 is designed for inserting the large 5/16" steel threaded inserts. Uses a standard wrench (not supplied with tool) to tighten insert into position.